

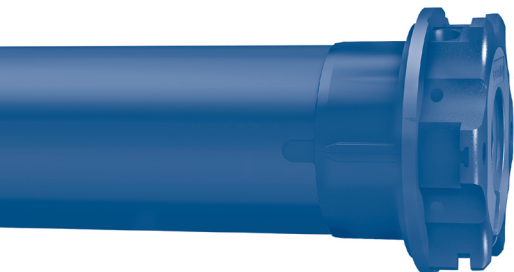

CHERUBINI

REBIS ZRX



MOTORE DOPPIA RADIO CON FINECORSA ELETTRONICO
PER TENDE TECNICHE E SCREEN

IT

DUAL RADIO MOTOR WITH ELECTRONIC LIMIT SWITCH
FOR SCREENS AND MOSQUITO NETS

EN

DUAL-FUNKMOTOR MIT ELEKTRONISCHEN ENDLAGEN
SCREENS

DE

MOTEUR À DOUBLE COMMANDE RADIO AVEC CONTACT
DE FINS DE COURSE ÉLECTRONIQUES POUR STORES VERTICAUX

FR

MOTOR RADIO DUAL CON FIN DE CARRERA ELECTRÓNICO
PARA CORTINA ENROLLABLE Y SCREEN

ES



ISTRUZIONI - INSTRUCTIONS - EINSTELLANLEITUNGEN
INSTRUCTIONS - INSTRUCCIONES

Table of contents:

Motor installation: main steps	p. 40
How to prepare the motor	p. 41
Electrical connections	p. 42
Compatible remote controls	p. 43
Key to symbols	p. 43-44
Command sequences example	p. 44
Function open/close programming remote control	p. 45-46
Setting the first remote control	p. 47
Automatic disabling of the first remote control setting function	p. 47
Setting of the limit switches	p. 48
Setting the closing limit switch	p. 48
Setting the opening limit switch	p. 48
Deleting the limit switch positions	p. 49
Deleting the closing limit switch	p. 49
Deleting the opening limit switch	p. 49
Total deleting of the limit switches	p. 49
Setting a middle position	p. 50
Deleting the middle position	p. 50
Closing force adjustment	p. 51
Maximum closing force adjustment (100%) - only for motors from 32 Nm -	p. 51
Setting of additional remote controls	p. 52
Remote control memory clearing	p. 52
Total deletion of the remote controls memory	p. 53
Special functions	
Additional middle position	p. 54
Setting the additional middle position	p. 54
Changing the additional middle position	p. 55
Deleting the additional middle position	p. 55
Short-term setting of a remote control	p. 55
Setting the A530058 pocket remote control	p. 56
Fabric tightening function	p. 57
Electric wiring to motor command for UP-DOWN mode (2 independent UP-DOWN buttons)	p. 58
Command management from white wire	p. 59
Super-sensitivity obstacle detection management during downwards movement ..	p. 59

Table of contents:

USING THE MOTOR INTO A Z-WAVE™ NETWORK

Device description	p. 60
Z-Wave™ technical specification	p. 60
Device installation	p. 61
Inclusion/exclusion the device into/from a Z-Wave™ network (classic)	p. 61
STANDARD inclusion (inclusion/exclusion).....	p. 62
SMARTSTART inclusion	p. 63
S2 SECURE inclusion	p. 63
Advanced settings	
Supported command classes	p. 64
Supporting COMMAND CLASS BASIC	p. 65
Supporting COMMAND CLASS INDICATOR	p. 65
Supporting COMMAND CLASS NOTIFICATION.....	p. 65
Control by COMMAND CLASS NOTIFICATION.....	p. 66
Device control	p. 67
Controlling REBIS ZRX by remote control and external switches	p. 67
Controlling REBIS ZRX by a Z-Wave™ controller.....	p. 68
Associations	p. 69
Reset to the factory settings	p. 70
Firmware update.....	p. 70
Configurations	p. 71-74
Declaration of conformity	p. 183

MOTOR INSTALLATION: MAIN STEPS

- Installing the motor into the awning
 - Wired connections
 - Connecting the remote control
 - Setting the limit switches.....
 - Installing the sensors (see sensor instructions)
 - Connecting to the Z-Wave™ system
- p. 41
p. 42
p. 47
p. 48
from p. 60

HOW TO PREPARE THE MOTOR

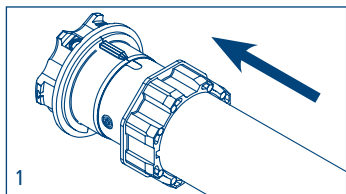
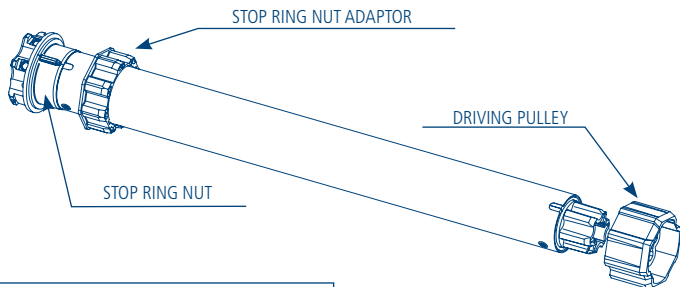

1. Insert the adaptor in the stop ring nut mating the groove with the reference notch and push till they touch.

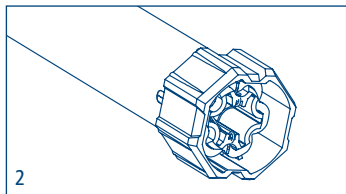

2. Fix the driving pulley on the motor pin until the stop pin clicks.

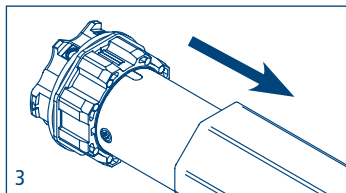

3. Insert the motor fully in the rolling tube.

NB: If you use tubes with a round form, the driving pulley must be fixed to the tube, and the installation is to be paid by the person who installs the system. For other tube sections the fitting is optional, but strongly recommended.

ELECTRICAL CONNECTIONS

- In order to prevent dangerous situations or malfunctioning, the electrical command elements wired to the motor must be sized according to the motor's electrical features.
- Means for disconnection must be incorporated in the fixed wiring in accordance with the national installation standards.
- For outdoor use, provide the appliance with a supply cable with designation H05RN-F containing at least 2% of carbon.
- If not used, the white wire must be insulated. It is dangerous to touch the white wire when the motor is powered.

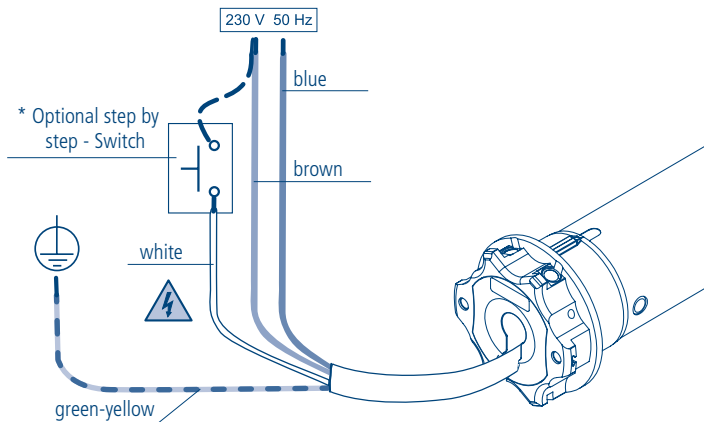

- * Installing this button is optional. The connection can be done differently using the brown wire or the blue wire. The button affords the possibility to command the motor in stepping mode (up, stop, down, stop, up, stop, down, stop..)

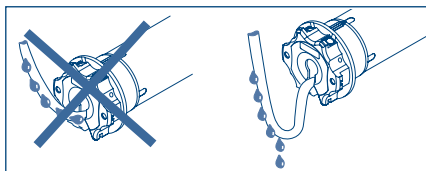

COMPATIBLE REMOTE CONTROLS

GIRO

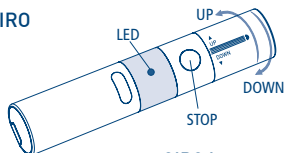

GIRO Wall

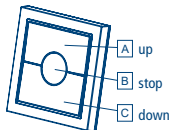

GIRO Plus

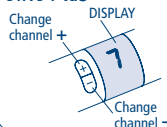

GIRO Lux

Activating the Sun sensor

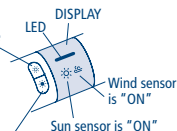

Deactivating the Sun sensor

GIRO P-Lux

Change channel

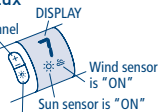

Activating/ Deactivating the Sun sensor

POP

POP Lux

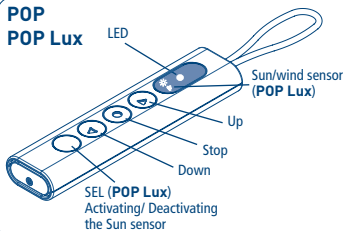

POP Plus

POP P-Lux

Sun/wind sensor (POP P-Lux)

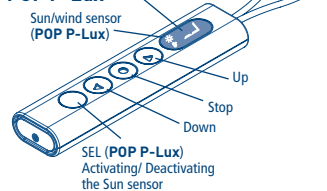

Activating/ Deactivating the Sun sensor

SKIPPER
SKIPPER Lux
SKIPPER PLUS
SKIPPER P-Lux

LED - SKIPPER
Display -
SKIPPER Lux
SKIPPER PLUS
SKIPPER P-Lux
Channel selector

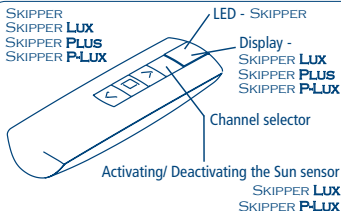

SKIPPER LCD
SKIPPER SENSO

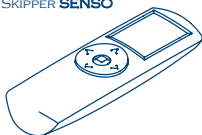

Check the specific instruction book

A530058 Remote Control with 4 independent channels



KEY TO SYMBOLS

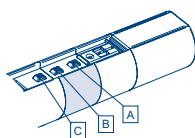

GIRO

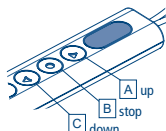

POP

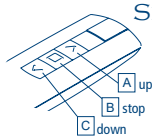

SKIPPER



KEY TO SYMBOLS

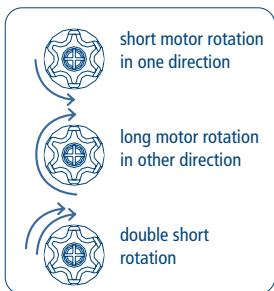
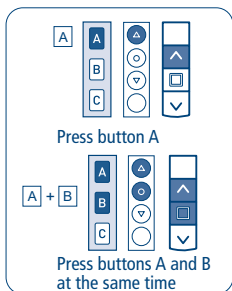
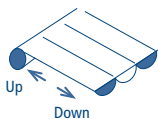

COMMAND SEQUENCES EXAMPLE

Most of the command sequences have three distinct steps, at the end of which the motor indicates if the step has been concluded positively or not, by turning in different ways. This section is provided to demonstrate the motor indications. The buttons must be pressed as shown in the sequence, without taking more than 4 seconds between one step and the next. If more than 4 seconds are taken, the command is not accepted and the sequence must be repeated. Command sequence example:

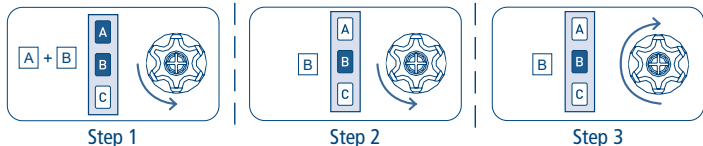

As we can see from the example, when the sequence ends positively, the motor returns to its starting position in one long rotation. In fact, two short rotations in the same direction correspond to one long rotation in the opposite direction. The motor returns to the starting position even when the sequence is not completed; in this case by performing one or two short rotations. Example of a wrong sequence:

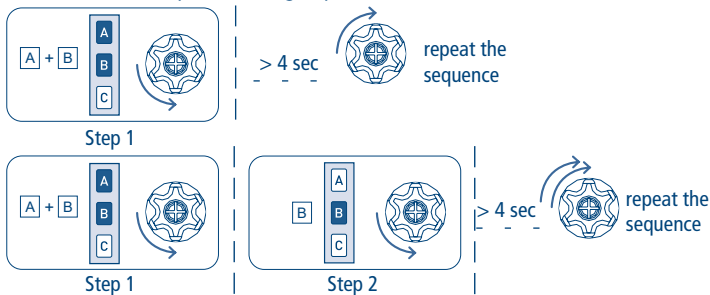

FUNCTION OPEN/CLOSE PROGRAMMING

REMOTE CONTROL SKIPPER PLUS - SKIPPER LUX - SKIPPER P-LUX

REMOTE CONTROL POP PLUS - POP LUX - POP P-LUX

To prevent accidental changes to the programming of the motor during the daily use of the remote control, the possibility of programming is disabled automatically 8 hours after sending the last sequence (A+B or B+C).

CHECKING THE STATUS OF THE FUNCTION

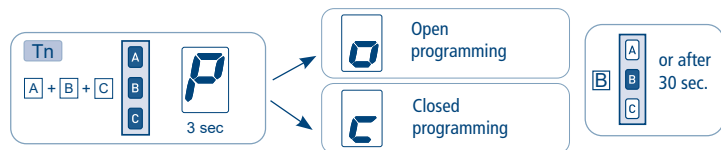

To change the status of the function, see the sequences "ENABLE/DISABLE PROGRAMMING".

ENABLE PROGRAMMING

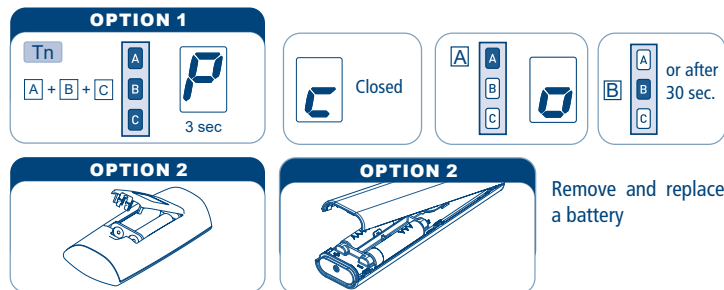

Proceed with programming as the instructions booklet.

DISABLE PROGRAMMING



FUNCTION OPEN/CLOSE PROGRAMMING

REMOTE CONTROL SKIPPER - SERIES GIRO - REMOTE CONTROL POP

To prevent accidental changes to the programming of the motor during the daily use of the remote control, the possibility of programming is disabled automatically 8 hours after sending the last sequence (A+B or B+C).

CHECKING THE STATUS OF THE FUNCTION

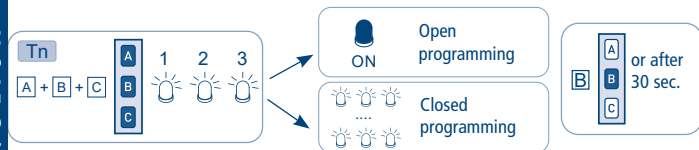

To change the status of the function, see the sequences "ENABLE/DISABLE PROGRAMMING".

ENABLE PROGRAMMING

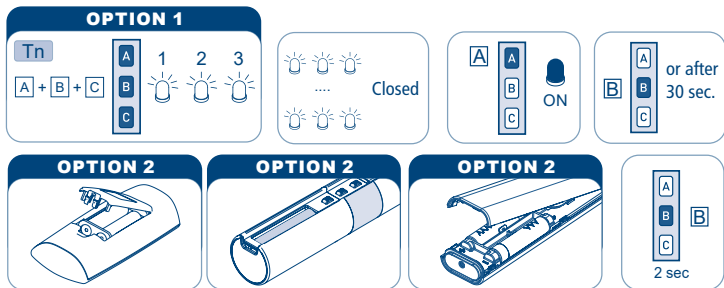

Remove one battery and wait minimum 5 seconds or press any button.

Proceed with programming as the instructions booklet.

DISABLE PROGRAMMING



SETTING THE FIRST REMOTE CONTROL

This operation can only be performed when the motor is new, or after a total delete of the memory.

During this step, power up only one motor at time!

T1: First remote control to be set

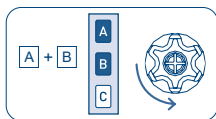

T1

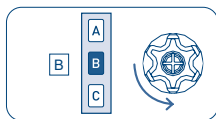

T1

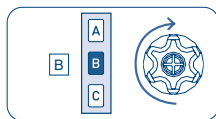

T1 (2 sec)

AUTOMATIC DISABLING OF THE FIRST REMOTE CONTROL SETTING FUNCTION

Every time you connect the power supply to the motor, you have 3 hours to store the first remote control. After this time, the ability to store the remote control is disabled. To reset the timer of the function you have to disconnect and reconnect the power supply to the motor.

SETTING OF THE LIMIT SWITCHES

Tubular motors have an electronic limit switch system with an encoder. This system ensures great reliability and precision in keeping the positions. Limit switch regulation is performed simply with the remote control. During setting, the motor moves only as long as the up or down button is pressed, stopping when the button is released.

At the end of setting, press either the up or down button briefly to move the motor.

SETTING THE CLOSING LIMIT SWITCH

After setting the remote control, it's necessary to set first the closing position!

For cassette-awnings, hold the button pressed until the motor stops automatically on the closing position. For open awnings, hold the button pressed and drive until the necessary closing position.

Notes: - If the awning is completely closed, you have firstly to open it by around 20 cm.

- Because the correct rotation direction will be identified only after the closing position is set, to close the awning, during setting the closing position, it's sometimes necessary to use the "down" button.

To set the closing position, hold pressed the "stop" button (around 2 sec) until the motor performs a short "down" movement.

Tn: Already programmed remote control

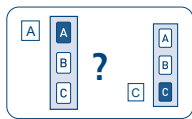

Tn

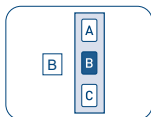
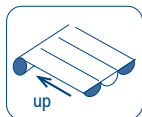

Tn (2 sec)



SETTING THE OPENING LIMIT SWITCH

After setting the closing position, open the awning until the necessary opening position by pressing the "down" button. You can use the "up"/"down" buttons to precisely set the opening position (in applications pergolas that allow this, you must press and hold the button until the motor stops automatically to the maximum opening).

To set the opening position, hold pressed the "stop" button (around 2 sec) until the motor performs a short "up" movement.

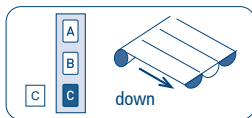

Tn

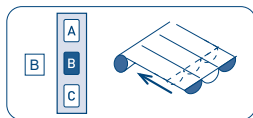

Tn (2 sec)

DELETING THE LIMIT SWITCH POSITIONS

DELETING THE CLOSING LIMIT SWITCH

To delete only the closing limit switch perform the following steps and proceed with "SETTING THE CLOSING LIMIT SWITCH".

Tn: Already programmed remote control

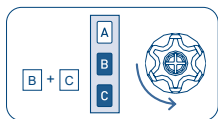

Tn

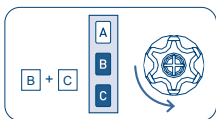

Tn

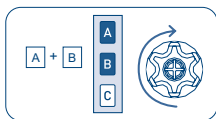

Tn (2 sec)

DELETING THE OPENING LIMIT SWITCH

To delete only the opening limit switch perform the following steps and proceed with "SETTING THE OPENING LIMIT SWITCH".

Tn: Already programmed remote control

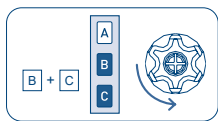

Tn

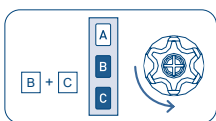

Tn

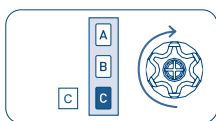

Tn (2 sec)

TOTAL DELETING OF THE LIMIT SWITCHES

Tn: Already programmed remote control

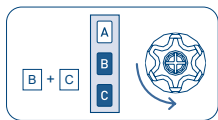

Tn

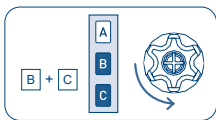

Tn

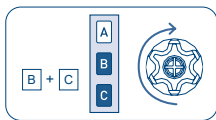

Tn (4 sec)

NB: by deleting the limit switches, the setting of the closing force is maintained (see p. 51).

SETTING A MIDDLE POSITION

This function allows to drive the awning to a favourite middle position. When this middle position is memorized, just press the STOP button for 2 seconds and automatically the motor will move the awning to this position.

To memorize the middle position, move the awning to the desired position and then hold the STOP button down (for about 4 seconds) until the motor gives confirmation.

Tn: Already programmed remote control

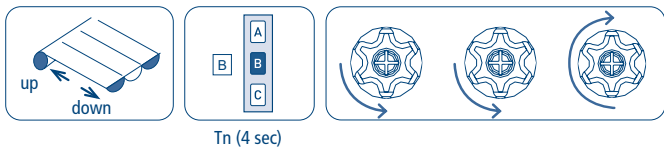

DELETING THE MIDDLE POSITION

If you want to delete the middle position, it can be done as described below. To change this position, it's also necessary to delete first the memorized middle position.

Before deleting the middle position, the awning must go to the middle position by pressing the STOP button for 2 second, then press the STOP button again (for about 4 seconds) until the motor performs the confirmation movement.

Tn: Already programmed remote control

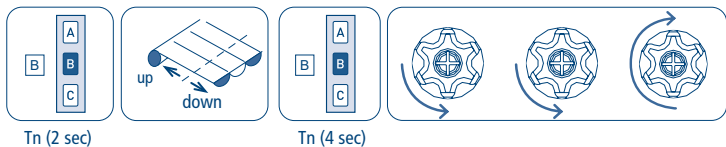

CLOSING FORCE ADJUSTMENT

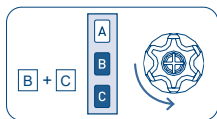

Tn

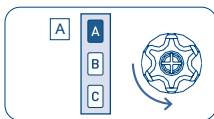

70 %

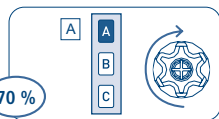

40 %

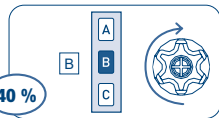

20 %

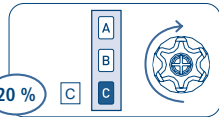

2 sec

This system, the only one of its kind, guarantees that cassette-awnings remain perfectly closed, without any danger of the canvas suffering excessive traction. The system works in all kinds of applications, thanks to the possibility of manually adjusting the closing force. The motor is factory set to a closing force of 40% of the nominal torque (e.g.: 40% of 50 Nm = 20 Nm). This force can be changed very easily by the remote control. It can be reduced by 20% or increased up to 70%, depending on the desired result.

MAXIMUM CLOSING FORCE ADJUSTMENT (100%) - only for motors from 32 Nm -

This function is factory-set for model variant 77.

A close attention on activating this function is recommended, excessive closing force may damage the awning.

By activating this function the motor will apply its maximum nominal torque, (e.g. 100% of 50 Nm = 50 Nm).

Tn: Already programmed remote control

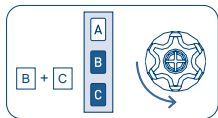

Tn

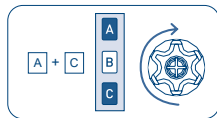
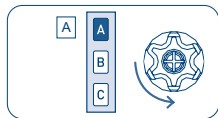

2 sec

SETTING OF ADDITIONAL REMOTE CONTROLS

Up to 15 remote controls can be set, including the light/wind sensor.

Tn: Already programmed remote control

Tx: Additional remote control

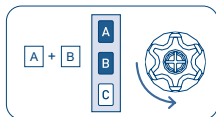

Tn

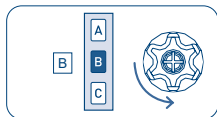

Tn

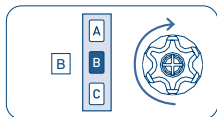

Tx (2 sec)

REMOTE CONTROL MEMORY CLEARING

It is possible to delete singly all the memorized remote controls. When the last one is deleted the motor initial condition is restored. The same applies to the single channels of a multichannel remote control: just select the channel to cancel.

Tn: Remote control to be cleared

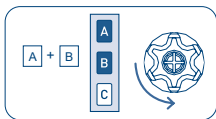

Tn

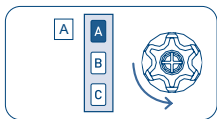

Tn

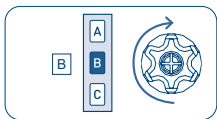

Tn (2 sec)

TOTAL DELETION OF THE REMOTE CONTROLS MEMORY

This full memory clearing does not delete the setting of the limit switch.

The full memory clearing can be performed in two ways:

1) WITH THE REMOTE CONTROL

Tn: Already programmed remote control

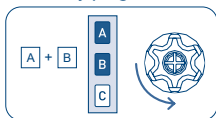

Tn

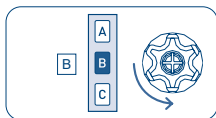

Tn

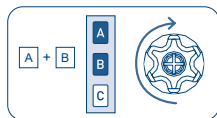

Tn (4 sec)

2) WITH THE WHITE WIRE

Do this operation only in case of emergency, if all remote controls are no longer operating. To delete the memory we have to access the white wire of the motor.

The sequence of this operation is the following:

- 1) Disconnect the power supply from the motor, via the main switch for example.
- 2) Connect the white motor wire to the brown wire (phase) or to the blue wire (neutral).
- 3) Connect the power supply to the motor, which rotates briefly in one direction.
- 4) Disconnect the power supply from the motor for at least 4 seconds.
- 5) Connect the power supply to the motor which performs one brief rotation in one direction after around 4 seconds and then a longer one in the opposite direction.
- 6) Disconnect the power supply from the motor.
- 7) Separate the white wire from the brow/blue wire. Insulate the white wire, in an appropriate way, before reconnecting the power supply.

At this point it is possible to proceed with the setting of the first remote control.

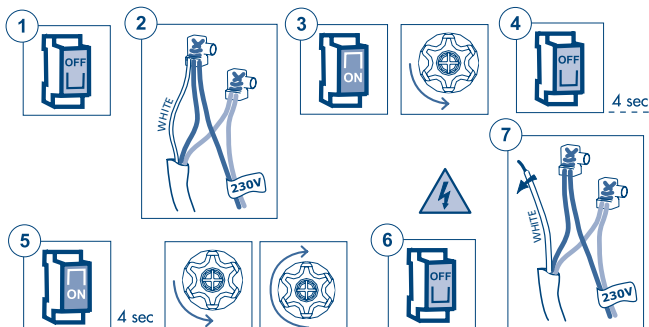

SPECIAL FUNCTIONS

ADDITIONAL MIDDLE POSITION

The additional middle position is useful to open the awning automatically through the WindTec Lux sensor and to bring it to a middle position when the light of the environment exceeds the threshold set. This additional middle position can be used only in combination with the light automatism of the WindTec Lux sensor.

The awning cannot be brought to this position with the remote control.

However, there is the possibility to program the current middle position using the B button (2 sec) command. If the additional middle position is not memorized, the light automatism of the WindTec Lux sensor (when enabled) opens the awning completely. When the WindTec Lux (Set button) sensor is tested, the movements of the motor do not take the additional middle position into consideration: the awning always stops in the half-way position and opens completely if the light exceeds the threshold value.

SETTING THE ADDITIONAL MIDDLE POSITION

After saving the limit switches, carry out the following command sequence:

Tn: Already programmed remote control

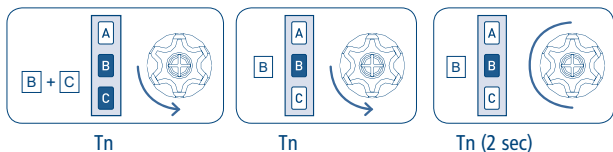

Starting from this moment, the motor moves in the "DEAD MAN" mode. This makes it possible to regulate the additional middle position in a precise way.

Carry out the following operations:

- Bring the awning to the desired open position.
- Press the B button of the remote control for about 2 seconds, until the motor gives a confirmation signal.

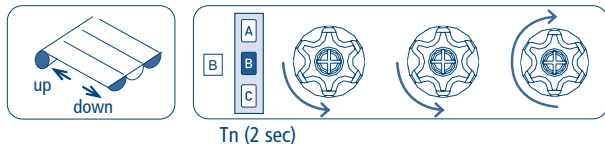

Starting from this moment, when the WindTec Lux commands the opening of the awning through the light automatism (if this is enabled), the awning will be brought to the additional middle position.

CHANGING THE ADDITIONAL MIDDLE POSITION

To change the additional middle position repeat the procedure described in the previous section.

DELETING THE ADDITIONAL MIDDLE POSITION

Carry out the following command sequence in order to cancel the additional middle position:

Tn: Already programmed remote control

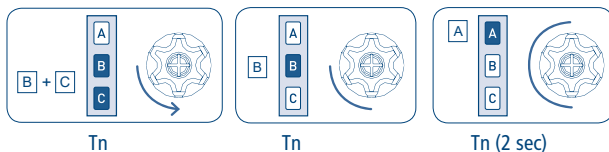

SHORT-TERM SETTING OF A REMOTE CONTROL

This function makes it possible to store a remote control temporarily, for example, with the purpose of setting the limit switches during assembly in the factory. A later final saving of the remote control will be possible using the appropriate command sequence (see: "SETTING THE FIRST REMOTE CONTROL"). The operations described below can be carried out only when the motor has just come out of the factory or after a full memory clearing (see: "FULL MEMORY CLEARING"). The motor makes the following operations possible only within the time limits described in order to make sure that the short-term setting is used only in the installation or factory setting phase and not during daily use.

Power up the motor, make sure that no other motors having an empty memory are powered up in the same operating range.

Within 30 seconds after start, press the B and C buttons simultaneously until the motor gives a confirmation signal.

The remote control will remain stored for 5 minutes, while the motor is powered up. After 5 minutes or when the motor has its power cut off, the remote control will be cancelled.

T1: First remote control to be set

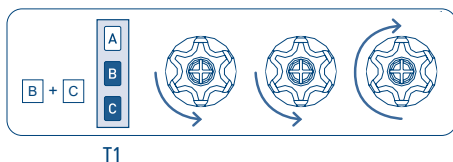

SETTING THE A530058 POCKET REMOTE CONTROL

NB: The new pocket remote control can be set only after programming of a previous remote control as the traditional Cherubini remote controls (Skipper, Giro or POP - 3 buttons Up-Down-Stop remote control).

HOW TO PROCEED TO SET THE BUTTON ON THE POCKET REMOTE CONTROL

Tn: Already programmed remote control

Tx: Pocket remote control to be set

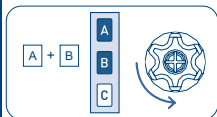

Tn

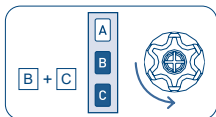

Tn

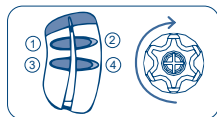

Tx (2 sec)

After to have pressed for minimal 2 seconds one of the 4 buttons on the pocket remote control, this one will be memorized on the step-by-step mode (UP-STOP-DOWN-STOP). The following buttons will be not memorized and have to be done with previous described sequence, and could be used to move additional motors.

DELETING ONE BUTTON ON THE POCKET REMOTE CONTROL

The buttons saved may be deleted individually according to the following sequence:

Tn: Already programmed remote control

Tx: Pocket remote control with button to be deleted

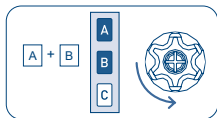

Tn

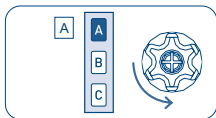

Tn

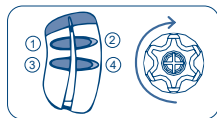

Tx (2 sec)

To confirm the operation the motor will do a short shunt and the button, which has to be pressed for minimal 2 second, will be deleted.

FABRIC TIGHTENING FUNCTION

By programming this function, the motor after reaching the outer limit, automatically performs a short backwards turn to tighten the fabric. Specially designed for pergolas and horizontal awnings.

N.B: The programming of this option can be made only after setting the limit switches.

STARTING THE SETTING PROCEDURE:

Tn: Already programmed remote control

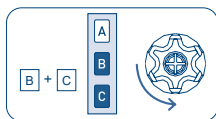

Tn

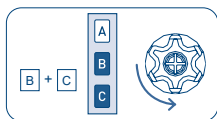

Tn

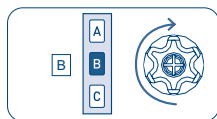

Tn (2 sec)

This first process brings the awning to the open position and sets the motor into "DEAD MAN" operating mode. Thereafter, the fabric tensioning position can be adjusted accurately.

ADJUSTMENT AND CONFIRMATION OF THE TENSIONING POSITION

Tn: Already programmed remote control

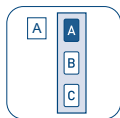

Tn



adjusting

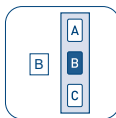

Tn (2 sec)

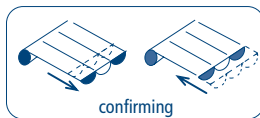

confirming

After adjusting and confirming the tensioning position, the motor drives to the open position and returns to the new tensioning position which has just been confirmed. From this moment, each time the motor reaches the open position, automatically it will turn back to the "tensioning position".

DELETING THE TENSIONING POSITION

Tn: Already programmed remote control

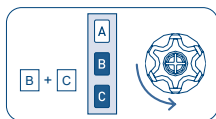

Tn

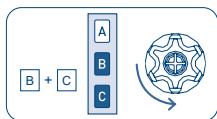

Tn

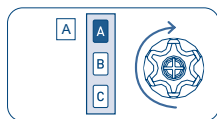

Tn (2 sec)

ELECTRIC WIRING TO MOTOR COMMAND FOR UP-DOWN MODE (2 independent UP-DOWN buttons)

To connect the switch, use only kind of switches with mechanical or electrical interlock, to prevent to press both buttons at same time.

The motor automatically recognizes the switch-type (with 1 or 2 buttons) and sets the proper operational mode.

ENGLISH

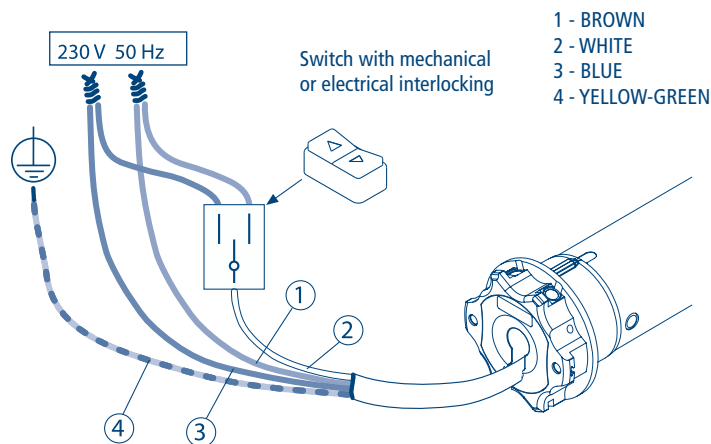

WIRE PROGRAMMING

Using the switch as described on this page it's possible to set the motor trough the white wire (wire programming). To find out this procedure, require the instruction pamphlet from your dealer.

COMMAND MANAGEMENT FROM WHITE WIRE UP-STOP-DOWN-STOP / UP-DOWN / UP-DOWN "DEAD MAN"

NB: The default function provided in the motors leaving the factory is UP-STOP-DOWN-STOP for singular UP/DOWN button switch. (Not for the switch with two independent UP-DOWN buttons!)

PROCEDURE TO CHANGE THE CONTROL MODE:

Tn: Already programmed remote control

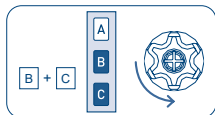

Tn

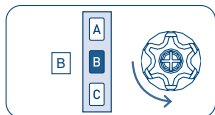

Tn

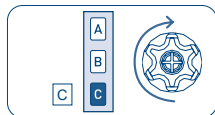

Tn (2 sec)

The possible settings are 3 and are available in the following order:

- UP-STOP-DOWN-STOP (factory setting)
- UP-DOWN (for 2 independent buttons)
- UP-DOWN "DEAD MAN" (for 2 independent buttons)

To switch from one setting to the following, perform the sequence as many times as necessary to reach the desired setting.

SUPER-SENSITIVITY OBSTACLE DETECTION MANAGEMENT DURING DOWNWARDS MOVEMENT (only for motors up to 25 Nm)

Where required - for example for window screens or screen fabric with a tensioner weight attached - it is possible to activate/deactivate a high level of obstacle detection sensitivity during downwards movement.

ACTIVATING THE SUPER-SENSITIVITY FUNCTION

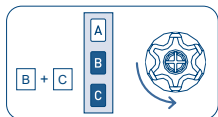

Tn

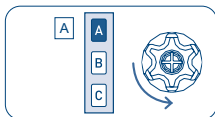

Tn

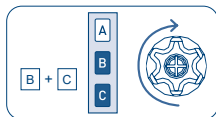

Tn (2 sec)

DEACTIVATING THE SUPER-SENSITIVITY FUNCTION

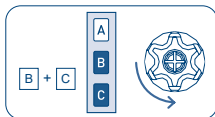

Tn

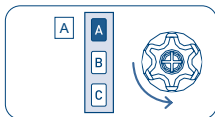

Tn

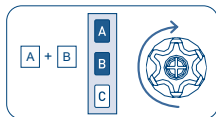

Tn (2 sec)

USING THE MOTOR INTO A Z-WAVE™ NETWORK

DEVICE DESCRIPTION

REBIS ZRX is a motor for awnings with programmable limit switches, dual-radio control and wired control option.

The limit switches can be adjusted manually, or acquired automatically by the motor, if the awnings is equipped with mechanical stop devices, on the up and/or down motion.

The dual-radio control allows, on the one hand, the adjustment of the limit switches and the main functions to be carried out simply and interactively and, on the other hand, to be integrated into a Z-Wave™ network.

The wired control option provides for both programming and motor control, from a simple switch, as an addition or as an alternative to the radio remote control. This product operates in any Z-Wave™ network with other Z-Wave™/Z-Wave Plus™ certified devices and controllers from any other manufacturer. As a constantly powered node, REBIS ZRX will act as repeater regardless of the vendor in order to increase the reliability of the network.

This device is a security enabled Z-Wave Plus™ product that is able to use encrypted Z-Wave Plus™ messages to communicate to other security enabled Z-Wave Plus™ products.

This device must be used in conjunction with a Security Enabled Z-Wave™ Controller in order to fully utilize all implemented functions.

Z-WAVE™ TECHNICAL SPECIFICATION

Power supply	230 VAC ±10% 50 Hz
Operating temperature	From -10° to 40° C
Power consumption in stand-by	< 1W
Radio frequency Z-Wave™	868,4 MHz
Radio frequency CRC	433,92 MHz
Protection system	S2 Security
Maximum range Z-Wave™	up to 100 m outdoor up to 40 m indoor
Compliance	CE, RoHs
Electrical IP Rating	IP44

DEVICE INSTALLATION

- 1) Carry out motor preparation and installation on the awning
- 2) Making electrical connections.
- 3) Program the limit switches, the adjustments and sensor associations as described in the product installation manual.
- 4) Include the device in the Z-Wave™ network

It is advisable to carry out all the preparation, installation and adjustment operations before including the motor in the Z-Wave™ network. Although it is possible to include the motor in a Z-Wave™ network, most features will not be active until the limit switches are adjusted. In particular, the following are not active:

- Movements control and position reporting
- Sending notifications
- Movement requested by Command class indicator

These limitations are necessary to limit the possibility of damage to the fabric and awning structure, as well as to protect the safety of the installer.

ADD/REMOVE THE DEVICE INTO A Z-WAVE™ NETWORK (classic)

REBIS ZRX is compatible with all Z-Wave™/Z-Wave Plus™ certified controllers. The devices support both the **Network Wide Inclusion** mechanism (which offers the ability to be included in a network, even if the device is not directly connected to the controller) and **Normal Inclusion**.

By default, the inclusion procedure starts in **Normal Inclusion** mode and after a short timeout the procedure continues in **Network Wide Inclusion** mode that lasts for about 20 Seconds.

Only a controller can add the device into the network. After activating the inclusion function by the controller, the device can be added by setting it in **Learn Mode**.

STANDARD INCLUSION (add/remove)

Make sure that the motor is powered and possibly connected to an up/down button if you wish to use the wired programming sequence, or have a remote control already saved in the motor. To make the inclusion, make sure that the motor is not already included in a Z-Wave™ network; if it is already included, perform the procedure described below, a first time to make the exclusion, and then a second time to make the inclusion.

The sequence of operations for inclusion/exclusion procedure is as follows:

- 1) Prepare the Z-Wave™ controller for inclusion (or exclusion) of a device (see your controller's instructions).
- 2) On the motor, run the programming sequence for inclusion/exclusion:
 - a. From the remote control: AB - AC - AB (2 seconds), wait for confirmation movements.

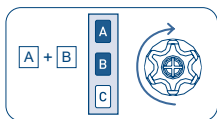
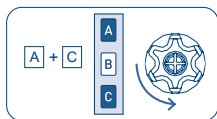
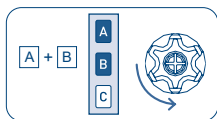

2 sec

- b. From the button (if the end stops are not adjusted, you can use either sequence indifferently):

- i. With the motor on the high limit switch: UP-UP-UP-UP-UP-DOWN

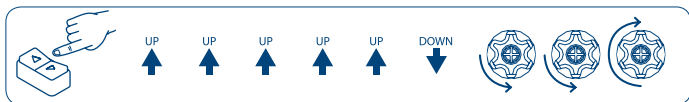

- ii. With the motor on the low limit switch: DOWN-DOWN-DOWN-DOWN-DOWN-UP

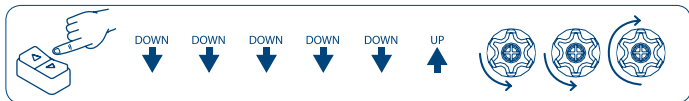

- 3) The motor performs a few short movements to indicate that the inclusion (or exclusion) procedure is in progress.
- 4) Check the controller make sure that the procedure was successful.

SMARTSTART INCLUSION

Z-Wave™ SmartStart aims to shift the tasks related to inclusion of an end device into a Z-Wave™ network away from the end device itself, and towards the more user-friendly interface of the gateway.

Z-Wave™ SmartStart removes the need for initiating the end device to start inclusion. Inclusion is initiated automatically on power-ON, and repeated at dynamic intervals for as long as the device is not included into a Z-Wave™ network. As the new device announces itself on power-ON, the protocol will provide notifications,

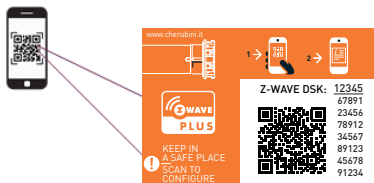

and the gateway can initiate the inclusion process in the background, without the need for user interaction or any interruption of normal operation. The SmartStart inclusion process only includes authenticated devices.

REBIS ZRX can be added into a Z-Wave™ network by scanning the Z-Wave™ QR Code present on the product with a controller providing SmartStart inclusion. No further action is required and the SmartStart product will be added automatically within 10 minutes of being switched on in the network vicinity.

The QR code and DSK in the numerical format are shown on the label on the motor cable. The PIN is the first group of 5 digits printed underlined. To facilitate consultation of these codes, the label has a detachable, self-adhesive part, which can be kept in the instruction manual, or applied in an easily accessible place on the roller shutter (box or final slat).

S2 SECURE INCLUSION

When adding REBIS ZRX to a Z-Wave™ network with a controller supporting Security 2 Authenticated (S2), the PIN code of the Z-Wave™ Device Specific Key (DSK) is required. The unique DSK code is printed on the product label. The first five digits of the key are highlighted and underlined to help the user identify the PIN code.



SUPPORTED COMMAND CLASSES

Command Class	Version	Non-Secure CC	Secure CC
COMMAND_CLASS_ZWAVEPLUS_INFO	2	x	
COMMAND_CLASS_APPLICATION_STATUS	1	x	
COMMAND_CLASS_DEVICE_RESET_LOCALLY	1		x
COMMAD_CLASS_INDICATOR	3		x
COMMAND_CLASS_ASSOCIATION	2		x
COMMAND_CLASS_MULTI_CHANNEL_ASSOCIATION	3		x
COMMAND_CLASS_ASSOCIATION_GRP_INFO	3		x
COMMAND_CLASS_TRANSPORT_SERVICE	2	x	
COMMAND_CLASS_VERSION	3		x
COMMAND_CLASS_MANUFACTURER_SPECIFIC	2		x
COMMAND_CLASS_POWERLEVEL	1		x
COMMAND_CLASS_CONFIGURATION	4		x
COMMAND_CLASS_SECURITY_2	1	x	
COMMAND_CLASS_SUPERVISION	1	x	
COMMAND_CLASS_FIRMWARE_UPDATE_MD	5		x
COMMAND_CLASS_BASIC	2		x
COMMAND_CLASS_WINDOW_COVERING	1		x
COMMAND_CLASS_SWITCH_MULTILEVEL	4		x
COMMAND_CLASS_NOTIFICATION	8		x
COMMAND_CLASS_PROTECTION	2		x

SUPPORTING COMMAND CLASS BASIC

The basic command classes are mapped into the Switch Multilevel Command Class.

Basic Command received	Mapped Command (Multilevel Switch)
Basic Set (0xFF)	Multilevel Switch (0xFF)
Basic Set (0x00)	Multilevel Switch (0x00)
Basic Set (1, 0x63)	Multilevel Switch (1, 0x63)
Basic GET	Basic Report (Current Value, Target Value, Duration) Current Value and Target Value MUST be set to 0xFE if not position aware

SUPPORTING COMMAND CLASS INDICATOR

The device supports the Command Class Indicator V3 (ID 0x50).

When the device receives an indicator set, the motor will perform opening and closing movements of the awning. The number of movements will be a maximum of 15, with a minimum stroke time of 0.5 s, and a minimum pause time of 0.5 s.

Note: to prevent damage to the fabric and tent structure, movements are only performed if the end switches have been saved.

SUPPORTING COMMAND CLASS NOTIFICATION

The device is able to send a System notification based on the information provided by the sensors linked to the motor:

- Rain: A520016 Rugiada
- Wind: A520007 Windtec, A520012 Mistral
- Wind - Light: A520008 Windtec Lux

Notification Event Code	The meaning associate to the event
9 (Digital Input State)	Wind above a threshold
10 (Digital Input State)	Light above a threshold
11 (Digital Input State)	Rain above a threshold
3 (System Error Failure)	This notification is sent when the motor reach an obstacle during its operation. The parameter event associate to this event is 1 Byte with the following meaning: 1) collision during opening 0) collision during closing

CONTROL BY COMMAND CLASS NOTIFICATION

The motor reacts by opening/closing and setting the protection, when it receives a System Notification.

The logic of processing notifications is as follows:

Notification Event Code	The meaning associate to the event
9 (Digital Input State)	Wind above a threshold
10 (Digital Input State)	Light above a threshold
11 (Digital Input State)	Rain above a threshold

- If the wind blows above the threshold: closing of the awning, activating the movement lock
- If the wind blows below the threshold: after 8 minutes, deactivation of the movement lock and reopening of the awning to the position before the wind alarm activation, if the motor has been programmed to perform this operation.
- With wind under the threshold:
 - o If rain is present: closing of the awning.
 - o If no rain: no operation
- With wind under the threshold and no rain:
 - o If the light goes above threshold: opening of the awning.
 - o If the light goes under the threshold: closing of the awning.

DEVICE CONTROL

CONTROLLING REBIS ZRX BY REMOTE CONTROL AND EXTERNAL SWITCHES

REBIS ZRX can also be controlled by radio remote control and by wired button.

The radio remote control is extremely useful when installing the motor on the awning, to set the limit switches and perform all programming and association functions with the climate sensors. After the first installation, the remote control can still be used as a local control point. All information regarding compatible devices and programming methods are described in the product installation manual.

From the remote control, you can execute the basic commands:

- Closing the awning: press and release the UP button
- Opening the awning: press and release the DOWN button
- Stop the awning: press and release the STOP button.

REBIS ZRX can also be controlled by a wired button, both single and a double-action (up/down).

With the single action button, the operation is as follows:

- Each time the button is pressed/released, the motor will perform the following operations in sequence: Closing, Stopping, Opening, Stopping and so on.

With the double-action button:

- Closing the awning: press and release the UP button
- Opening the awning: press and release the DOWN button
- Stop the awning: press and release the UP or DOWN button while the motor is moving.

When leaving the factory:

- No remote control is associated with the motor. The motor can be controlled via a wired button, but until the limit switches are set, it moves in 'dead man' mode: when the button is released, the motor stops.
- As long as the limit switches are not set, the direction of movement of the motor may be reversed, compared to the remote control and the wired double-action button. The direction is correctly identified automatically by the motor itself when the limit switches are set and cannot be changed.

Further information about the operation of the remote control and the wired button can be found in the product installation manual.

CONTROLLING REBIS ZRX BY A Z-WAVE™ CONTROLLER

REBIS ZRX can be controlled by any Z-Wave™ / Z-Wave Plus™ certified controller available in the market. In the figure below, is represented an example of a *control panel interface* that shows how the device will appear once included into the Gateway

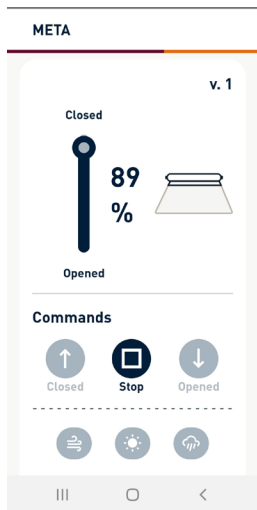

By moving the cursor in the scrollbar is possible to regulate the opening level of the awning.

ASSOCIATIONS

The device supports 4 association groups, each of which supports the association of up to 8 devices (nodes):

Group ID	Group Name	N° max node	Description	Command sent
1	Lifeline	8	Life Line Group	Window Covering Report, Switch Multilevel Report, Device Reset Locally Notification, Notification Report, Protection Report, Indicator Report, Configuration Report,
2	Follow-me	8	Nodes belonging to this group will follow the device level.	Basic Set
3	Scene Activation	8	Nodes belonging to this group receive an Activation Scene ID if an obstacle is reached during its operation. The Scene ID can be defined by using parameters 30, 31	Scene Activation Set
4	Follow-me Weather	8	Nodes belonging to this group will follow the device level if the change is due by the weather conditions. The parameter ID Window Covering Set can be configured by using parameter 32.	Window Covering Set



INFO: Association ensures direct transfer of control commands between devices, and is performed without participation of the main controller.

RESET TO THE FACTORY SETTINGS

The Z-Wave™ configuration of the REBIS ZRX motor can be reset to the original factory values with the following programming sequence:

- 1) From the remote control: AB - AC - BC (4 seconds), wait for confirmation movements to be executed.

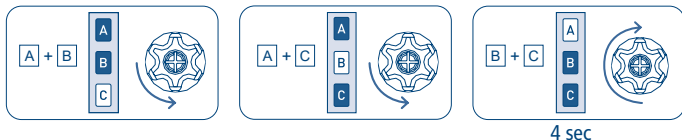

- 2) From the button (if the end stops are not adjusted, you can use either sequence indifferently):

- a. With the motor on the high limit switch: UP-UP-UP-DOWN-UP-DOWN

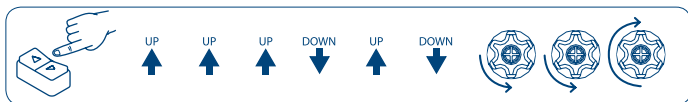

- b. With the motor on the low limit switch: DOWN-DOWN-DOWN-UP-DOWN-UP

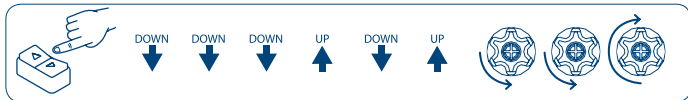

Please use this procedure only when the network primary controller is missing or otherwise inoperable.



INFO: If the reset is performed while the device is still part of a network, it notifies the other devices in the Lifeline Group that it has been removed (**Device Reset Locally Notification**).

FIRMWARE UPDATE

The system supports over-the-air firmware updates that do not require the device to be removed from its location. The firmware update can be activated from all certified controllers supporting version 2 of the Firmware Update function.



WARNING: The system will be rebooted at the end of the firmware update procedure. It is advisable to carry out the firmware update procedure only when necessary and following careful planning of the intervention.

CONFIGURATIONS

Parameter Number	Size	Parameter Name	Default Value	Description
30	2	OPEN_COLLISION_SCENE_ID	0	Scene ID sent if a collision is detected during opening operation. 0 no scene ID is sent.
Parameters Values			Min: 0	Max: 254
Value	Description			
0	Do not send the scene activation			
1- 254	The scene ID sent for the collision during Opening			

Parameter Number	Size	Parameter Name	Default Value	Description
31	2	CLOSE_COLLISION_SCENE_ID	0	Scene ID sent if a collision is detected during closing operation. 0 no scene ID is sent.
Parameters Values			Min: 0	Max: 254
Value	Description			
0	Do not send the scene activation			
1- 254	The scene ID sent for the collision during Closing			

Parameter Number	Size	Parameter Name	Default Value	Description
32	1	PARAM_ID	13	Parameter ID used by the window covering set on group: Follow me weather
Parameters Values			Min: 0	Max: 23
Value	Description			
0-23	Send the Window covering set using this parameter ID			

Parameter Number	Size	Parameter Name	Default Value	Description
33	1	MOVEMENT_TRIGGER	0	Read-only parameter. Used to describe the reason of the last movement

Parameters Values **Min: 0** **Max: 3**

Value	Description
0	requested by the user
1	Wind
2	Sun
3	Rain

Parameter Number	Size	Parameter Name	Default Value	Description
34	1	AUTOMATION_CONFIG	5	Used to define for which event the automation is active.

Parameters Values **Min: 5** **Max: 7**

Value	Description
1	Wind Automation is active (always active, cannot be disabled)
2	Sun Automation
4	Rain Automation (always active, cannot be disabled)

The value of this parameter is the sum of wind, sun, rain status.
 Since Automation for Wind and Rain are always activated the only valid value are:
 5 to disable the SUN automation
 7 to enable the SUN automation

Parameter Number	Size	Parameter Name	Default Value	Description
35	1	SENSOR_ACTIVATION_STATUS	0	Read-only parameter. Used to describe which sensor has been associated to the motor

Parameters Values Min: 0 Max: 7

Value	Description
1	No sensors are associated to the motor
2	Wind Sensor
3	Sun Sensor
4	Rain Sensor

The value of this parameter is the sum of wind, sun, rain status.

Parameter Number	Size	Parameter Name	Default Value	Description
36	1	LOST_LIFE_SIGNAL	0	Read-only parameter. Used to describe which sensor has been associated to the motor

Parameters Values Min: 0 Max: 1

Value	Description
0	Connection with the sensors is alive
1	Connection with the sensors has been lost

Parameter Number	Size	Parameter Name	Default Value	Description
37	1	LEVEL_REPORT_PERIOD	5	Used to define the level report frequency.

Parameters Values Min: 2 Max: 60

Value	Description
2-60	Define the time frequency from a level report to the next ones (expressed in seconds)

Parameter Number	Size	Parameter Name	Default Value	Description
38	1	COLLISION_STATUS	2	Read-only parameter. Used to tell if a collision happened in the last movement.
Parameters Values			Min: 0	Max: 2
Value	Description			
0	Collision During opening operation			
1	Collision During closing operation			
2	No collision			

IT DICHIARAZIONE DI CONFORMITÀ UE

- CE** CHERUBINI S.p.A. dichiara che il prodotto è conforme alle pertinenti normative di armonizzazione dell'Unione:
Direttiva 2014/53/UE, Direttiva 2011/65/UE.
Il testo completo della dichiarazione di conformità UE è disponibile facendone richiesta sul sito: www.cherubini.it.

EN EU DECLARATION OF CONFORMITY

- CE** CHERUBINI S.p.A. declares that the product is in conformity with the relevant Union harmonisation legislation:
Directive 2014/53/EU, Directive 2011/65/EU.
The full text of the EU declaration of conformity is available upon request at the following website: www.cherubini.it.

DE EU-KONFORMITÄTSEKTLÄRUNG

- CE** CHERUBINI S.p.A. erklärt der produkt erfüllt die einschlägigen Harmonisierungsrechtsvorschriften der Union:
Richtlinie 2014/53/EU, Richtlinie 2011/65/EU.
Der vollständige Text der EU-Konformitätserklärung kann unter unserer Web-Seite www.cherubini.it, gefragt werden.

FR DÉCLARATION UE DE CONFORMITÉ

- CE** CHERUBINI S.p.A. déclare que le produit est conforme à la législation d'harmonisation de l'Union applicable:
Directive 2014/53/UE, Directive 2011/65/UE.
Le texte complet de la déclaration UE de conformité est disponible en faisant requête sur le site internet: www.cherubini.it.

ES DECLARACIÓN UE DE CONFORMIDAD

- CE** CHERUBINI S.p.A. declara que el producto es conforme con la legislación de armonización pertinente de la Unión:
Directiva 2014/53/UE, Directiva 2011/65/UE.
El texto completo de la declaración UE de conformidad puede ser solicitado en: www.cherubini.it.

CHERUBINI S.p.A.

Via Adige 55
25081 Bedizzole (BS) - Italy
Tel. +39 030 6872.039 | Fax +39 030 6872.040
info@cherubini.it | www.cherubini.it

CHERUBINI Iberia S.L.

Avda. Unión Europea 11-H
Apdo. 283 - P. I. El Castillo
03630 Sax Alicante - Spain
Tel. +34 (0) 966 967 504 | Fax +34 (0) 966 967 505
info@cherubini.es | www.cherubini.es

CHERUBINI France SAS

ZI Du Mas Barbet
165 Impasse Ampère
30600 Vauvert - France
Tél. +33 (0) 466 77 88 58
info@cherubini.fr | www.cherubini.fr

CHERUBINI Deutschland GmbH

Siemensstrasse, 40 - 53121 Bonn - Deutschland
Tel. +49 (0) 228 962 976 34 / 35 | Fax +49 (0) 228 962 976 36
info@cherubini-group.de | www.cherubini-group.de

