

CHERUBINI

tocco italiano dal 1947

PLUG&PLAY SHORT RX

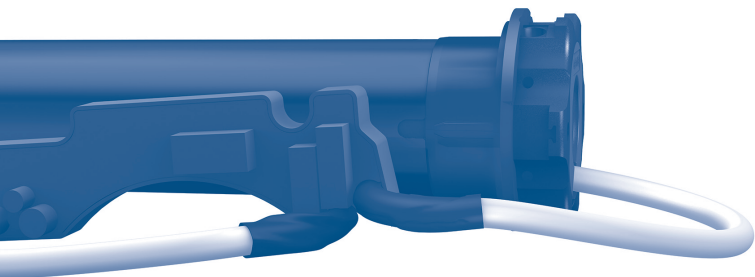

MOTORE TUBOLARE CON REGOLAZIONE AUTOMATICA
DEL FINECORSO ELETTRONICO

IT

TUBULAR MOTOR WITH AUTOMATIC ADJUSTMENT
OF THE ELECTRONIC LIMIT SWITCH

EN

ROHRMOTOR MIT AUTOMATISCHER EINSTELLUNG
DER ELEKTRONISCHEN ENDLAGEN

DE

MOTEUR TUBULAIRE AVEC RÉGLAGE AUTOMATIQUE
DES FINS DE COURSE ÉLECTRONIQUES

FR

MOTOR TUBULAR CON REGULACIÓN AUTOMÁTICA
DEL FIN DE CARRERA ELECTRONICO

ES



ISTRUZIONI - INSTRUCTIONS - EINSTELLANLEITUNGEN
INSTRUCTIONS - INSTRUCCIONES

Table of contents:

Electrical connections	p. 23-24
How to prepare the motor	p. 25
Compatible remote controls	p. 26
Key to symbols	p. 27
Command sequences example	p. 28
Function open/close programming remote control	p. 29-30
Operational modes	p. 31
Setting the first remote control and setting the rotation direction of the motor	p. 31
Automatic disabling of the first remote control setting function	p. 32
Limit switches and obstacle detection	p. 33
Closing force adjustment	p. 33
Super-sensitivity obstacle detection management during downwards movements ..	p. 33
First middle position	p. 34
Second middle position	p. 35
2-Button switch	p. 36
Command management from white wire	
UP-STOP-DOWN-STOP / UP-DOWN / UP-DOWN "DEAD MAN"	p. 36
Operation in UP-DOWN mode (for 2 independent buttons)	p. 37
Deleting the limit switch positions	p. 38
Setting of additional remote controls	p. 38
Remote control memory clearing	p. 38
Full memory clearing	p. 39
Special functions: short-term setting of a remote control and setting the rotation direction of the motor	p. 40
EU Declaration of conformity	p. 98

ELECTRICAL CONNECTIONS

- To prevent any danger or malfunction, the size of electrical control components connected to the motor must be compatible with the electrical features of the motor.
- Means for disconnection must be incorporated in the fixed wiring in accordance with the national installation standards.
- The selectors inverting the direction of rotation of the motor must be provided with mechanical interlocking.
- **NEVER** connect two or more selectors to the same motor.
- For outdoor use, provide the appliance with a supply cord with designation H05RN-F containing at least 2% of carbon.
- To avoid short circuits, arrange an automatic bipolar switch with opening distance of the contacts of at least 3 mm before the circuit.
- If not used, the white wire must be insulated. It is dangerous to touch the white wire when the motor is powered.

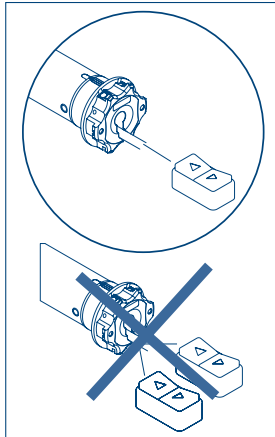
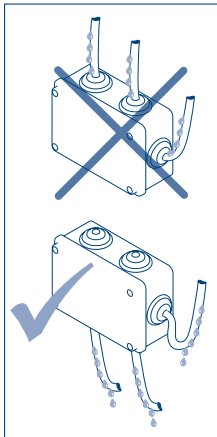
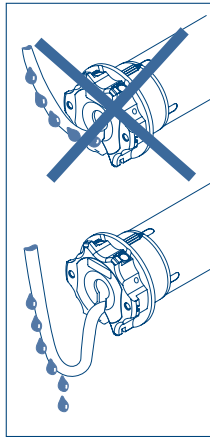

ELECTRICAL CONNECTIONS



ENGLISH

Series GIRO

Series SKIPPER

Series POP

230 V 50 Hz

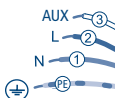

230 V 50 Hz



PE 1 2 3

- 1 - NEUTRAL
- 2 - PHASE
- 3 - WIRED SWITCH (WHITE)
- PE - EARTH

- ① BLUE
- ② BROWN
- ③ WHITE (WIRED SWITCH)
- PE YELLOW-GREEN

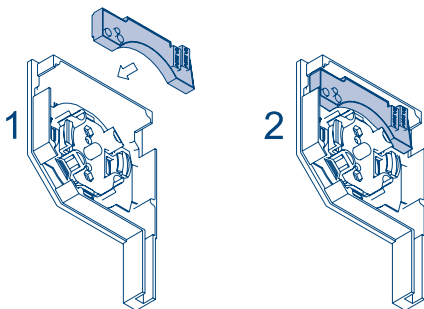

HOW TO PREPARE THE MOTOR

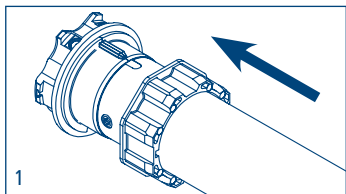
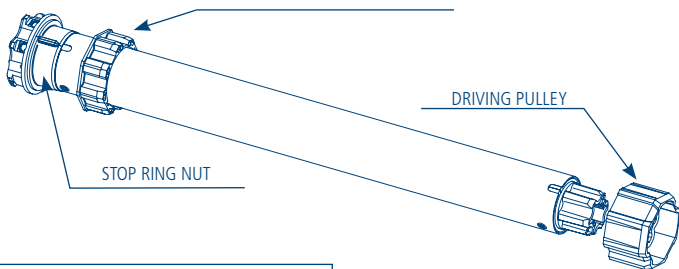

1. Insert the adaptor in the stop ring nut mating the groove with the reference notch and push till they touch.

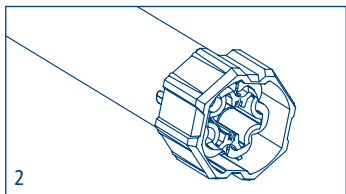

2. Fix the driving pulley on the motor pin until the stop pin clicks.

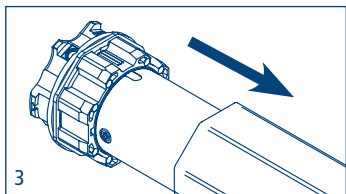

3. Insert the motor fully in the rolling tube.

NB: If you use tubes with a round form, the driving pulley must be fixed to the tube, and the installation is to be paid by the person who installs the system. For other tube sections the fitting is optional, but strongly recommended.

COMPATIBLE REMOTE CONTROLS

GIRO

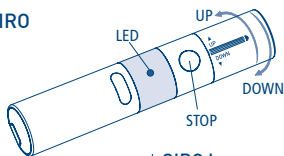

GIRO Wall

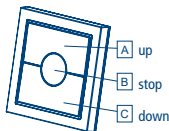

GIRO Plus

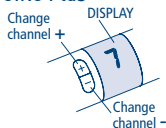

GIRO Lux

Activating the Sun sensor

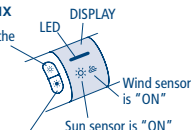

Deactivating the Sun sensor

GIRO P-Lux

Change channel



Activating/ Deactivating the Sun sensor

POP POP Lux

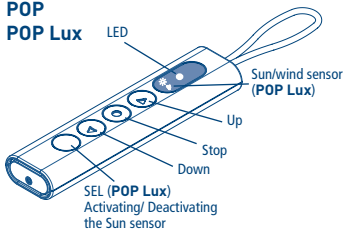

POP Plus POP P-Lux

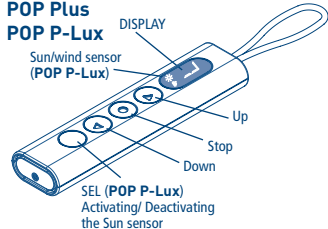

SKIPPER
SKIPPER Lux
SKIPPER PLUS
SKIPPER P-LUX

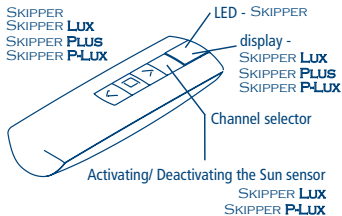

SKIPPER LCD
SKIPPER SENSO

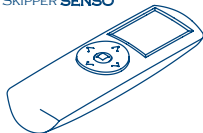

Check the specific instruction book

KEY TO SYMBOLS

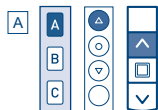
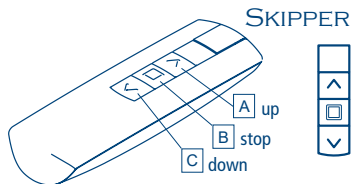
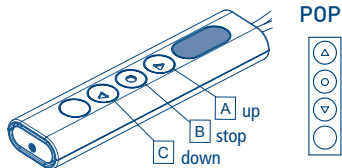
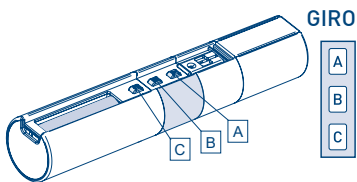
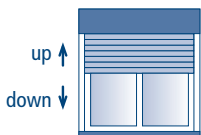

Press button A

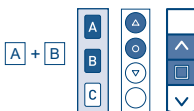

Press buttons A and B
at the same time



Press the
bottom
UP



Press the
bottom
DOWN



Release



short motor rotation
in one direction



long motor rotation
in other direction



double short
rotation

COMMAND SEQUENCES EXAMPLE

Most of the command sequences have three distinct steps, at the end of which the motor indicates if the step has been concluded positively or not, by turning in different ways. This section is provided to demonstrate the motor indications. The buttons must be pressed as shown in the sequence, without taking more than 4 seconds between one step and the next. If more than 4 seconds are taken, the command is not accepted and the sequence must be repeated.

Command sequence example:

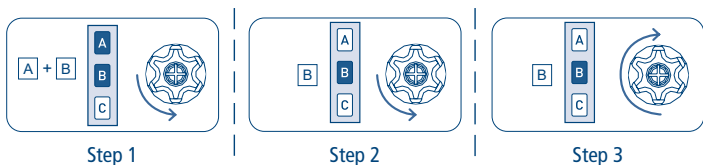

As we can see from the example, when the sequence ends positively, the motor returns to its starting position in one long rotation. In fact, two short rotations in the same direction correspond to one long rotation in the opposite direction. The motor returns to the starting position even when the sequence is not completed; in this case by performing one or two short rotations.

Example of a wrong sequence:

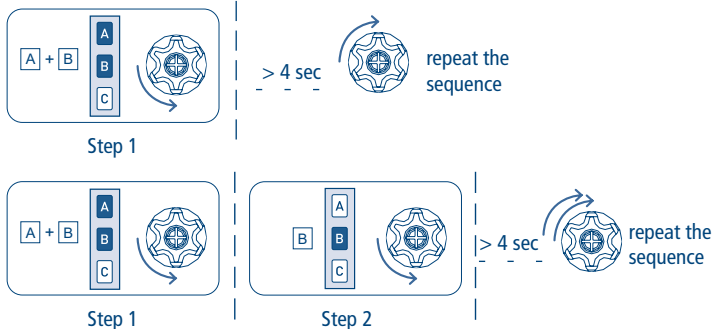

FUNCTION OPEN/CLOSE PROGRAMMING

REMOTE CONTROL SKIPPER PLUS - SKIPPER LUX - SKIPPER P-LUX

REMOTE CONTROL POP PLUS - POP LUX - POP P-LUX

To prevent accidental changes to the programming of the motor during the daily use of the remote control, the possibility of programming is disabled automatically 8 hours after sending the last sequence (A+B or B+C).

CHECKING THE STATUS OF THE FUNCTION

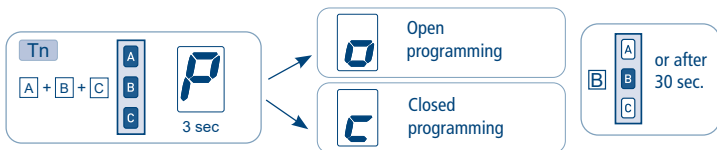

To change the status of the function, see the sequences "ENABLE/DISABLE PROGRAMMING".

ENABLE PROGRAMMING

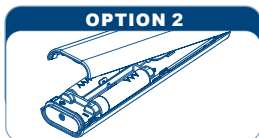
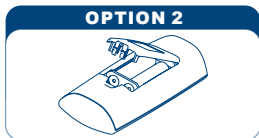
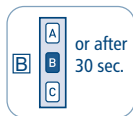
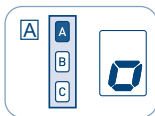
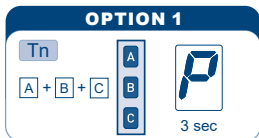

Remove and replace a battery

Proceed with programming as the instructions booklet.

DISABLE PROGRAMMING

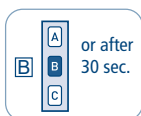
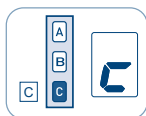
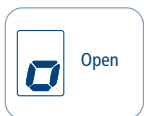
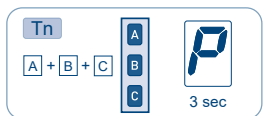

FUNCTION OPEN/CLOSE PROGRAMMING REMOTE CONTROL SKIPPER - SERIES GIRO - REMOTE CONTROL POP

To prevent accidental changes to the programming of the motor during the daily use of the remote control, the possibility of programming is disabled automatically 8 hours after sending the last sequence (A+B or B+C).

CHECKING THE STATUS OF THE FUNCTION

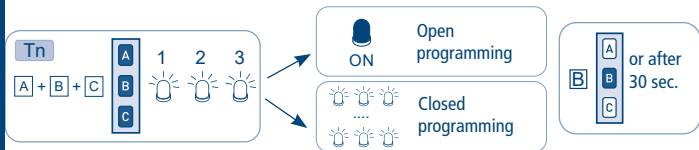

To change the status of the function, see the sequences "ENABLE/DISABLE PROGRAMMING".

ENABLE PROGRAMMING

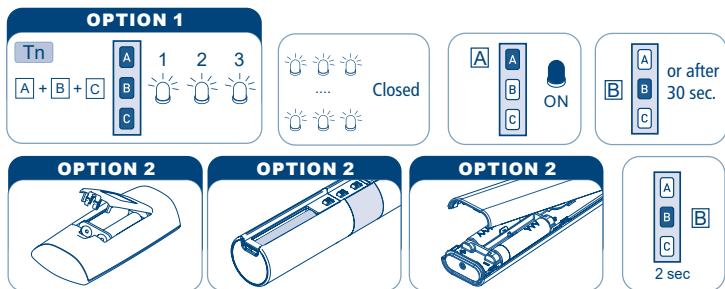

Remove one battery and wait minimum 5 seconds or press any button.

Proceed with programming as the instructions booklet.

DISABLE PROGRAMMING



OPERATIONAL MODES

The tubular motor is very simple to be used and installed, it does not need any regulation as it automatically detects the position of limit switch.

The rolling shutter must be equipped with:

- a) security locks or stiff fixing springs,
- b) fixed or removable stoppers for end slats.

It is very important to check the sturdiness of the rolling shutter.

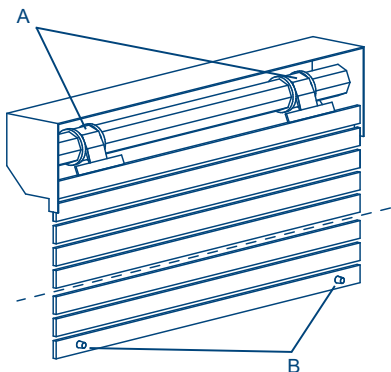

SETTING THE FIRST REMOTE CONTROL AND SETTING THE ROTATION DIRECTION OF THE MOTOR

This operation can only be performed when the motor is new, or after a total delete of the memory.

During this step, power up only one motor at time!

T1: First remote control to be set

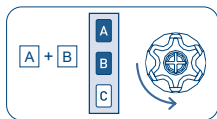

T1

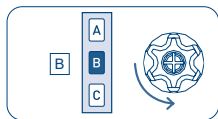

T1

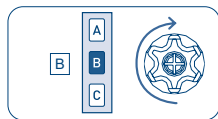

T1 (2 sec)

After the last confirmation movement, the motor starts a series of UP and DOWN movements: the first lasts 2 seconds, the next ones go max 10 seconds. To properly associate the UP and DOWN buttons, press the button corresponding to the motor movement for one second as indicated below:

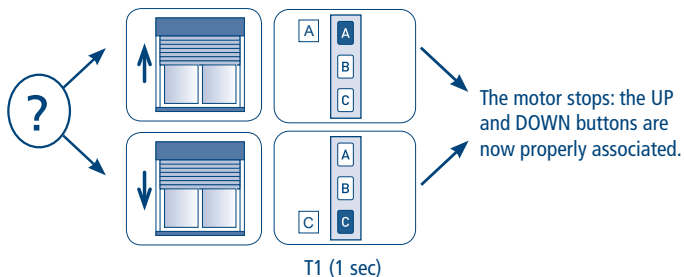

AUTOMATIC DISABLING OF THE FIRST REMOTE CONTROL SETTING FUNCTION

Every time you connect the power supply to the motor, you have 3 hours to store the first remote control. After this time, the ability to store the remote control is disabled. To reset the timer of the function you have to disconnect and reconnect the power supply to the motor.

LIMIT SWITCHES AND OBSTACLE DETECTION

After having memorized the first remote control and properly assigned the rotation direction, the motor is ready for operation.

Run two complete ascent and descent cycles with the A and C buttons on the remote control to memorise the operating times and enable obstacle detection.

In the event an obstacle is detected, the motor will perform a safety movement in reverse equal to about $\frac{1}{4}$ of the blind travel.

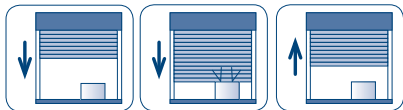

CLOSING FORCE ADJUSTMENT

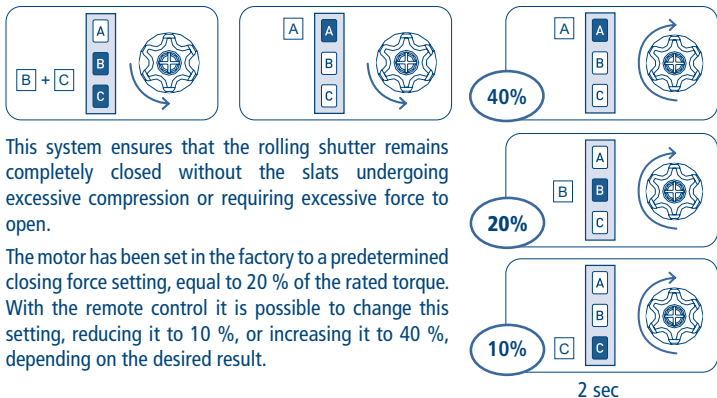

SUPER-SENSITIVITY OBSTACLE DETECTION MANAGEMENT DURING DOWNWARDS MOVEMENTS

Where required, it is possible to activate/deactivate a high level of obstacle detection sensitivity during downwards movement. This Super-sensitivity is automatically disabled when the blinds slats begin to pile up.

ACTIVATING THE SUPER-SENSITIVITY FUNCTION

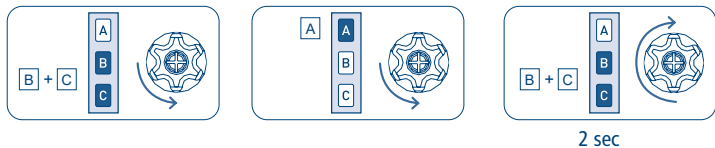

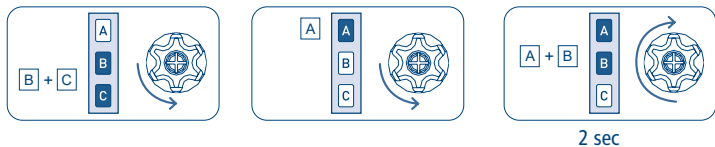

DEACTIVATING THE SUPER-SENSITIVITY FUNCTION



FIRST MIDDLE POSITION

This optional function enables the blinds to be moved to a first preferred middle position. The first middle position is memorized as descent time starting from the upper limit switch.

SETTING FIRST MIDDLE POSITION

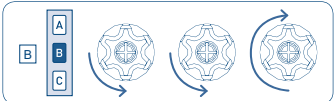
Procedure	Command sequence
<p>1) Press the A+B buttons for at least 2 s.</p> <p><i>The motor will immediately perform a brief confirmation movement and after 2 s will start again in ascent.</i></p>	 <p>2 sec</p>
<p>2) Wait for the blind to ascend completely.</p> <p><i>The motor is now running in dead man mode, enabling the fine adjustment of the first middle position.</i></p>	 <p>Adjustment</p>
<p>3) Confirm the position by pressing B for 2 s.</p> <p><i>The motor will perform three (3) confirmation movements.</i></p>	 <p>2 sec</p>

MOVEMENT TO THE FIRST MIDDLE POSITION

Procedure	Command sequence
<p>1) Give a long (>2 s) stop impulse with the motor stopped.</p> <p><i>After 2 seconds, the motor will perform the movement into position.</i></p>	 <p>2 sec</p> <p>Positioning</p>

DELETING THE FIRST MIDDLE POSITION



SECOND MIDDLE POSITION

This optional function enables the blind to be brought to a second preferred middle position, which may be used, for example, as a ventilation position. The second middle position is memorized as ascent time starting from the bottom limit switch.

SETTING SECOND MIDDLE POSITION

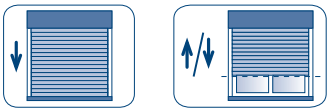
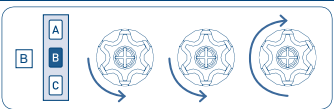
Procedure	Command sequence
<p>1) Press the B+C buttons for at least 2 s.</p> <p><i>The motor will immediately perform a brief confirmation movement and after 2 s will start again in descent.</i></p>	 <p>2 sec</p>
<p>2) Wait for the blind to descend completely.</p> <p><i>The motor is now running in dead man mode, enabling the fine adjustment of the second middle position.</i></p>	 <p>Adjustment</p>
<p>3) Confirm the position pressing B for 2 s.</p> <p><i>The motor will perform three (3) confirmation movements.</i></p>	 <p>2 sec</p>

MOVEMENT TO THE SECOND MIDDLE POSITION

Procedure	Command sequence
<p>1) Press the A+C buttons with the motor stopped.</p> <p><i>The motor will perform the movement into position.</i></p>	 <p>Positioning</p>

DELETING THE SECOND MIDDLE POSITION



2-BUTTON SWITCH

It is possible to run the motor through a switch connected with three wires (up, down and common).

The switch must be equipped with mechanical or electrical interlock, to prevent two commands being sent simultaneously. Furthermore, the switch must be an unstable pushbutton: releasing it, the switch opens.

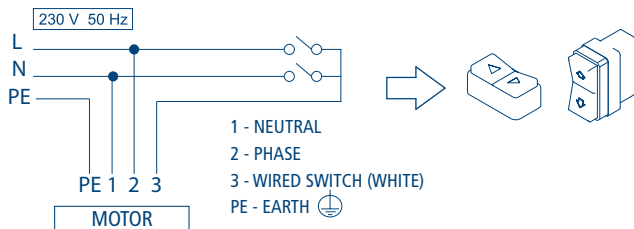

The motor automatically recognizes the switch-type (with 1 or 2 buttons) and sets the proper operational mode.

COMMAND MANAGEMENT FROM WHITE WIRE UP-STOP-DOWN-STOP / UP-DOWN / UP-DOWN "DEAD MAN"

NB: The default function provided in the motors leaving the factory is: UP-STOP-DOWN-STOP for singular UP/DOWN button switch. (Not for the switch with two independent UP-DOWN buttons!)

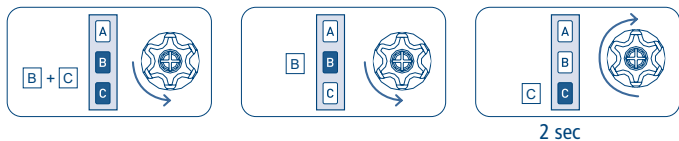

The possible settings are 3 and are available in the following order:

- UP-STOP-DOWN-STOP (factory setting)
- UP-DOWN (for 2 independent buttons)
- UP-DOWN "DEAD MAN" (for 2 independent buttons)

To switch from one setting to the following, perform the sequence as many times as necessary to reach the desired setting.

OPERATION IN UP-DOWN MODE (for 2 independent buttons)



Pressing one of the two buttons and releasing, the motor drives to the desired direction until it reaches the limits.



To stop the motor before reaching the limits press again the same button.



If during the movement the other button is pressed the motor changes the direction.

MOVEMENT TO THE FIRST MIDDLE POSITION

 press briefly < 1 sec	 release	< 0,5 sec	 press briefly < 1 sec	 release
------------------------------	-------------	-------------------	--	-------------

MOVEMENT TO THE SECOND MIDDLE POSITION

 press briefly < 1 sec	 release	< 0,5 sec	 press and hold > 1 sec	 release
------------------------------	-------------	-------------------	---	-------------

In "DEAD MAN" mode it is not possible to move to the middle positions from the switch.

DELETING THE LIMIT SWITCH POSITIONS

During operation, the motor automatically acquires the limit switch positions. In the event that the length or position of the limit switches need to be changed, the positions already acquired by the control unit will need to be deleted.

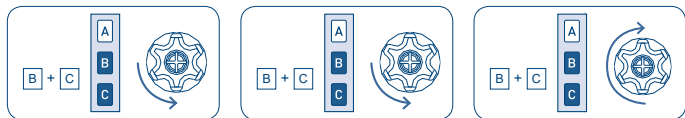

At the end of the sequence, the motor is ready to automatically acquire the new limit switch positions.

ATTENTION! This operation deletes all the memorized middle positions.

SETTING OF ADDITIONAL REMOTE CONTROLS

Up to 15 remote controls can be set.

Tn: Already programmed remote control

Tx: Additional remote control

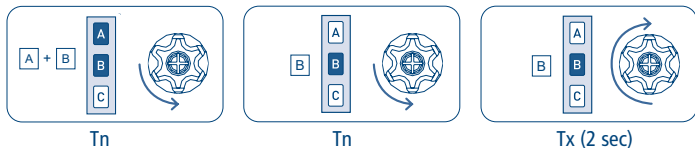

REMOTE CONTROL MEMORY CLEARING

It is possible to delete singly all the memorized remote controls. When the last one is deleted the motor initial condition is restored. The same applies to the single channels of a multichannel remote control: just select the channel to cancel before performing the sequence.

Tn: Remote control to be cleared

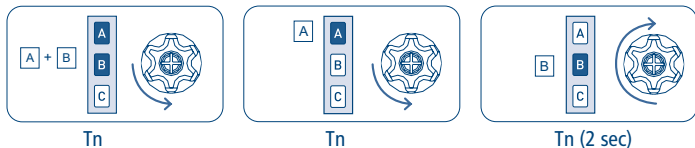

FULL MEMORY CLEARING

The full memory clearing can be performed in two ways:

1) WITH THE REMOTE CONTROL

Tn: Already programmed remote control

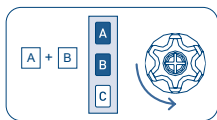

Tn

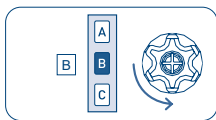

Tn

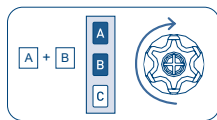

Tn (4 sec)

2) WITH THE WHITE WIRE

Do this operation only in case of emergency, if all remote controls are no longer operating. To delete the memory we have to access the white wire of the motor.

The sequence of this operation is the following:

- 1) Disconnect the power supply from the motor, via the main switch for example.
- 2) Connect the white wire to the brown wire (phase) or to the blue wire (neutral).
- 3) Connect the power supply to the motor, which rotates briefly in one direction.
- 4) Disconnect the power supply from the motor for at least 4 seconds.
- 5) Connect the power supply to the motor which performs one brief rotation in one direction after around 4 seconds and then a longer one in the opposite direction.
- 6) Disconnect the power supply from the motor.
- 7) Separate the white wire from the brow/blue wire. Insulate the white wire, in an appropriate way, before reconnecting the power supply.

At this point it is possible to proceed with the setting of the first remote control.

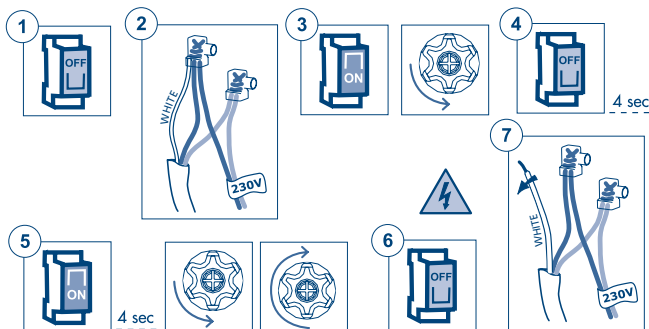

SPECIAL FUNCTIONS

SHORT-TERM SETTING OF A REMOTE CONTROL AND SETTING THE ROTATION DIRECTION OF THE MOTOR

This function makes it possible to store a remote control temporarily, for example, with the purpose of setting the limit switches during assembly in the factory. A later final saving of the remote control will be possible using the appropriate command sequence (see: "SETTING THE FIRST REMOTE CONTROL"). The operations described below can be carried out only when the motor is just come out of the factory or after a full memory clearing (see: "FULL MEMORY CLEARING"). The motor makes the following operations possible only within the time limits described in order to make sure that the short-term setting is used only in the installation or factory setting phase and not during daily use. Power up the motor, make sure that no other motor having an empty memory are powered up in the same operating range.

Within 30 seconds after start, press the B and C buttons simultaneously until the motor gives a confirmation signal.

T1: First remote control to be set

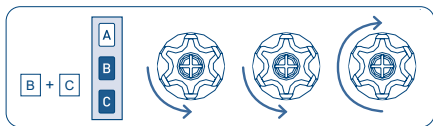

T1

After the last confirmation movement, the motor starts a series of UP and DOWN movements: the first lasts 2 seconds, the next ones go to max 10 seconds.

To properly associate the UP and DOWN buttons, press the button corresponding to the motor movement for one second as indicated below:

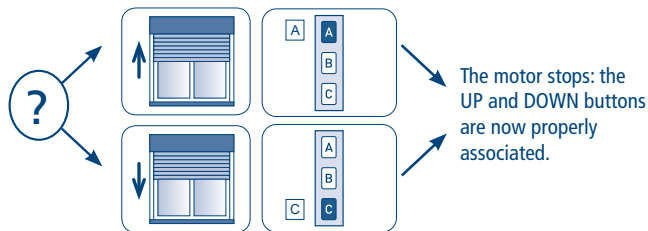

T1 (1 sec)

The remote control will remain stored for 5 minutes, while the motor is powered up. After 5 minutes or when the motor has its power cut off, the remote control will be cancelled.

IT DICHIARAZIONE DI CONFORMITÀ UE

CE CHERUBINI S.p.A. dichiara che il prodotto è conforme alle pertinenti normative di armonizzazione dell'Unione:

Direttiva 2014/53/UE, Direttiva 2011/65/UE.

Il testo completo della dichiarazione di conformità UE è disponibile facendone richiesta sul sito: www.cherubini.it.

EN EU DECLARATION OF CONFORMITY

CE CHERUBINI S.p.A. declares that the product is in conformity with the relevant Union harmonisation legislation:

Directive 2014/53/EU, Directive 2011/65/EU.

The full text of the EU declaration of conformity is available upon request at the following website: www.cherubini.it.

DE EU-KONFORMITÄTSERKLÄRUNG

CE CHERUBINI S.p.A. erklärt der produkt erfüllt die einschlägigen Harmonisierungsrechtsvorschriften der Union:

Richtlinie 2014/53/EU, Richtlinie 2011/65/EU.

Der vollständige Text der EU-Konformitätserklärung kann unter unserer Web-Seite www.cherubini.it, gefragt werden.

FR DÉCLARATION UE DE CONFORMITÉ

CE CHERUBINI S.p.A. déclare que le produit est conforme à la législation d'harmonisation de l'Union applicable:

Directive 2014/53/UE, Directive 2011/65/UE.

Le texte complet de la déclaration UE de conformité est disponible en faisant requête sur le site internet: www.cherubini.it.

ES DECLARACIÓN UE DE CONFORMIDAD

CE CHERUBINI S.p.A. declara que el producto es conforme con la legislación de armonización pertinente de la Unión:

Diretiva 2014/53/UE, Directiva 2011/65/UE.

El texto completo de la declaración UE de conformidad puede ser solicitado en: www.cherubini.it.

CHERUBINI S.p.A.

Via Adige 55
25081 Bedizzole (BS) - Italy
Tel. +39 030 6872.039 | Fax +39 030 6872.040
info@cherubini.it | www.cherubini.it

CHERUBINI Iberia S.L.

Avda. Unión Europea 11-H
Apdo. 283 - P. I. El Castillo
03630 Sax Alicante - Spain
Tel. +34 (0) 966 967 504 | Fax +34 (0) 966 967 505
info@cherubini.es | www.cherubini.es

CHERUBINI France S.a.r.l.

ZI Du Mas Barbet
165 Impasse Ampère
30600 Vauvert - France
Tél. +33 (0) 466 77 88 58 | Fax +33 (0) 466 77 92 32
info@cherubini.fr | www.cherubini.fr

CHERUBINI Deutschland GmbH

Siemensstrasse, 40 - 53121 Bonn - Deutschland
Tel. +49 (0) 228 962 976 34 / 35 | Fax +49 (0) 228 962 976 36
info@cherubini-group.de | www.cherubini-group.de

