

# CHERUBINI

tocco italiano dal 1947

## PLUG&PLAY OCEAN EASY

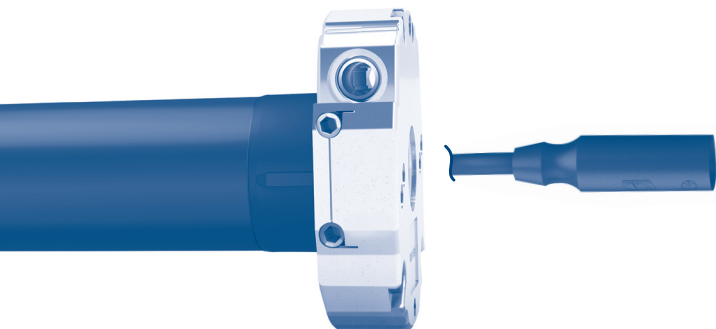

MOTORI TUBOLARI CON CONNETTORE EASY  
E MANOVRA DI SOCCORSO

IT

TUBULAR MOTORS WITH EASY CONNECTOR  
AND MANUAL OVERRIDE DEVICE

EN

ROHRMOTOREN MIT EASY-STECKVERBINDUNG  
UND NHK-NOTHANDKURBELGETRIEBE

DE

MOTEURS TUBULAIRES AVEC CONNECTEUR EASY  
ET MANOEUVRE DE SECOURS

FR

MOTORES TUBULARES CON CONECTOR EASY  
Y MANIOBRA DE EMERGENCIA

ES



ISTRUZIONI - INSTRUCTIONS - EINSTELLANLEITUNGEN  
INSTRUCTIONS - INSTRUCCIONES



## ELECTRICAL CONNECTIONS

- To prevent any danger or malfunction, the size of electrical control components connected to the motor must be compatible with the electrical features of the motor.
- Means for disconnection must be incorporated in the fixed wiring in accordance with the national installation standards.
- The selectors inverting the direction of rotation of the motor must be provided with mechanical interlocking.
- Invert the brown and the black conductor to change the direction of rotation.
- **NEVER** connect two or more selectors to the same motor.
- For outdoor use, provide the appliance with a supply cable with designation H05RN-F containing at least 2% of carbon.
- Cable length between motor and control-switch maximal 50 m.  
In case of cable length more than 50 m an interface-relay have to be used.

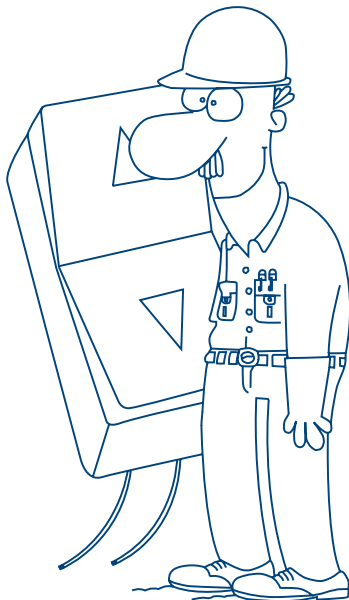
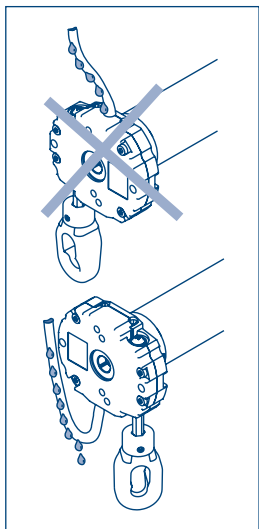

230 V 50 Hz

- 1- brown
- 2- black
- 3- blue
- 4- yellow-green

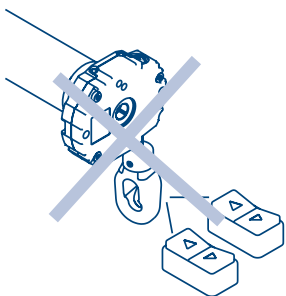
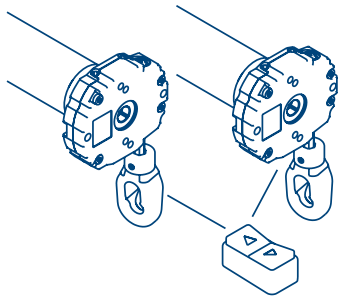
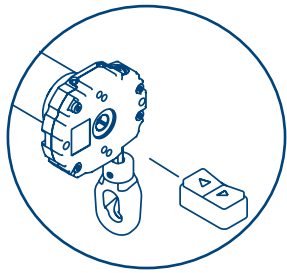
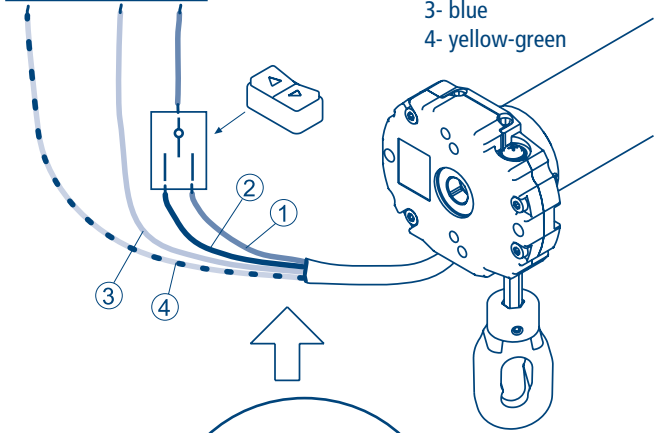

ENGLISH

## HOW TO PREPARE THE MOTOR

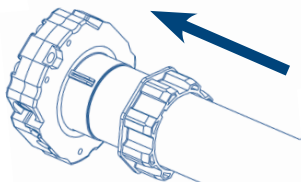
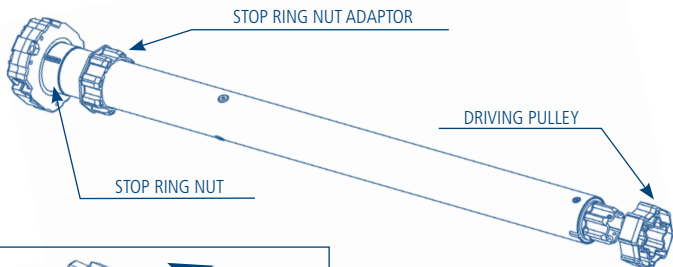

1. Insert the adaptor in the stop ring nut mating the groove with the reference notch and push till they touch.

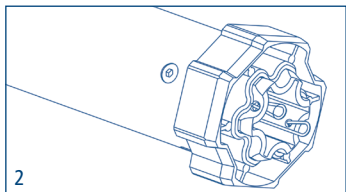

2. Fix the driving pulley on the motor pin until the stop pin clicks.

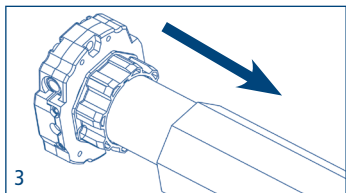

3. Insert the motor fully in the rolling tube.

**NB:** If you use tubes with a round form, the driving pulley must be fixed to the tube, and the installation is to be paid by the person who installs the system. For other tube sections the fixing is optional but strongly recommended.

## KEY TO SYMBOLS



Press the  
UP-button



Press the  
DOWN-button

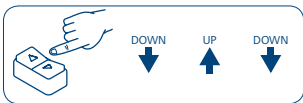

Press the buttons quickly according to the sequence indicated.

## COMAND SEQUENCES EXAMPLE

Most of the command sequences have three or six distinct steps.

The buttons must be pressed for less than 0.5 seconds as shown in the sequence, without taking more than 1 second between one step and the next. If more than 1 second is taken, the command is not accepted and the sequence must be repeated.

Command sequence example:

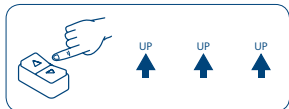

**Attention!** If the sequence requires a repetition of the same commands (Up+Up/ Down+Down), an interposition of the Stop position could be necessary depending on the type of switch in use.

## INSTRUCTION FOR USE

The tubular motor is very simple to be used and installed, it does not need any regulation as it automatically detects the position of limit switch.

The rolling shutter must be equipped with:

- A - security locks or stiff fixing springs,
- B - fixed or removable stoppers for end slats.

It is very important to check the sturdiness of the rolling shutter.

Execute a complete cycle of opening and closing before using the manual override device.

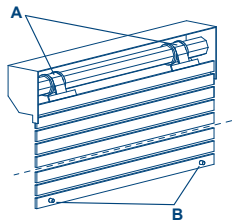

**Note:** After manual override, the motor resets the proper positions upon reaching a valid limit switch position.

## RESTORING THE ORIGINAL CONFIGURATION

Restoring the original configuration can be achieved in two ways, with the button switch sequence:

### from the OPENING position

Bring the rolling shutter to the upper limit switch and proceed as follows:

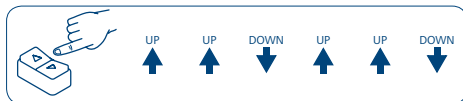

### from the CLOSING position

Bring the rolling shutter to the lower limit switch and proceed as follows:

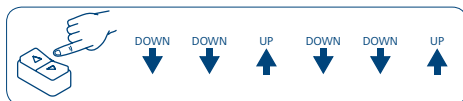

OR

with wired connection:

- Connect both the brown and black motor wires under the same switch, e.g. UP.
- Press the UP button for at least 2 seconds.
- Disconnect and then restore the original control switch electrical connections (see p. 9).

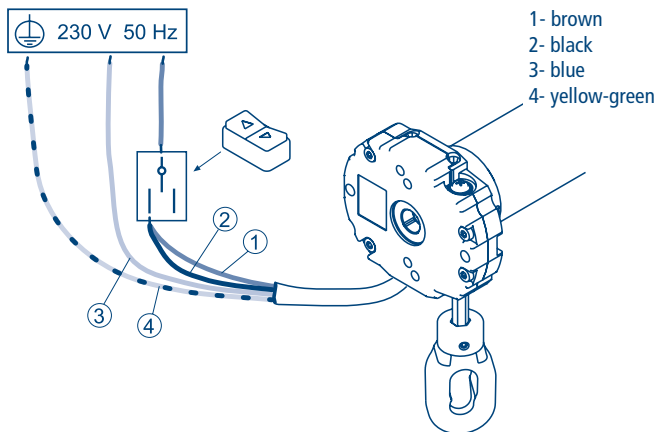





## **IT** Dichiarazione di conformità UE



CHERUBINI S.p.A. dichiara che il prodotto è conforme alle pertinenti normative di armonizzazione dell'Unione:

Direttiva 2014/35/UE

Direttiva 2014/30/UE

Direttiva 2011/65/UE

Il testo completo della dichiarazione di conformità UE è disponibile facendone richiesta sul sito: [www.cherubini.it](http://www.cherubini.it).

## **EN** EU Declaration of conformity



CHERUBINI S.p.A. declares that the product is in conformity with the relevant Union harmonisation legislation:

Directive 2014/35/EU

Directive 2014/30/EU

Directive 2011/65/EU

The full text of the EU declaration of conformity is available upon request at the following website: [www.cherubini.it](http://www.cherubini.it).

## **DE** EU-Konformitätserklärung



CHERUBINI S.p.A. erklärt der produkt erfüllt die einschlägigen Harmonisierungsrechtsvorschriften der Union:

Richtlinie 2014/35/EU

Richtlinie 2014/30/EU

Richtlinie 2011/65/EU

Der vollständige Text der EU-Konformitätserklärung kann unter unserer Web-Seite [www.cherubini.it](http://www.cherubini.it), gefragt werden.

## **FR** Déclaration UE de conformité



CHERUBINI S.p.A. déclare que le produit est conforme à la législation d'harmonisation de l'Union applicable:

Directive 2014/35/UE

Directive 2014/30/UE

Directive 2011/65/UE

Le texte complet de la déclaration UE de conformité est disponible en faisant requête sur le site internet: [www.cherubini.it](http://www.cherubini.it).

## **ES** Declaración UE de conformidad



CHERUBINI S.p.A. declara que el producto es conforme con la legislación de armonización pertinente de la Unión:

Directiva 2014/35/UE

Directiva 2014/30/UE

Directiva 2011/65/UE

El texto completo de la declaración UE de conformidad puede ser solicitado en: [www.cherubini.it](http://www.cherubini.it).

**Note - Bem - Notes - Notas:**

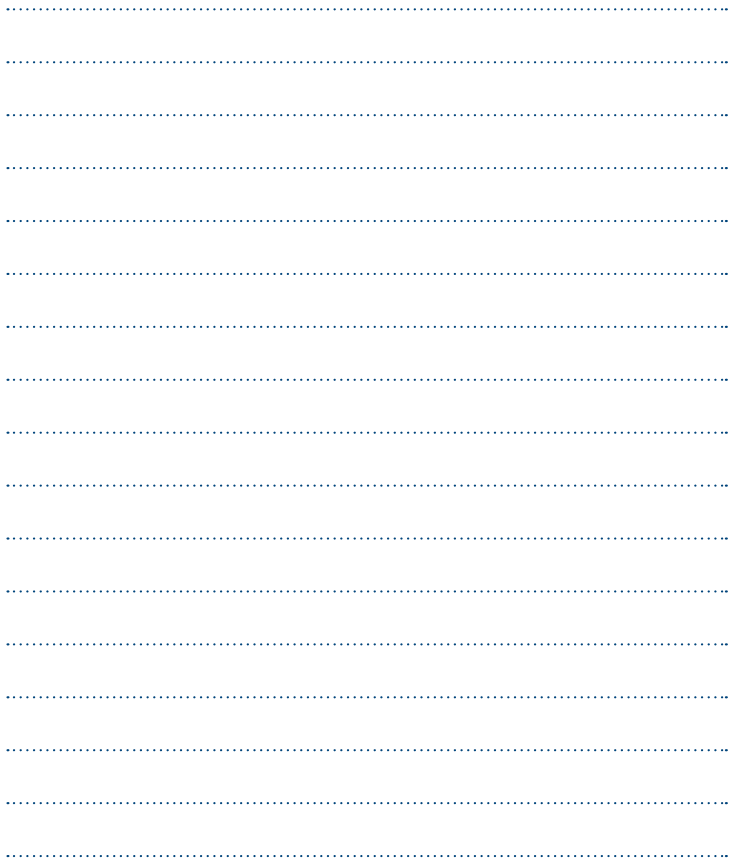

A series of 19 horizontal dotted lines, evenly spaced, intended for writing notes.



**CHERUBINI S.p.A.**

Via Adige 55  
25081 Bedizzole (BS) - Italy  
Tel. +39 030 6872.039 | Fax +39 030 6872.040  
info@cherubini.it | www.cherubini.it

**CHERUBINI Iberia S.L.**

Avda. Unión Europea 11-H  
Apdo. 283 - P. I. El Castillo  
03630 Sax Alicante - Spain  
Tel. +34 (0) 966 967 504 | Fax +34 (0) 966 967 505  
info@cherubini.es | www.cherubini.es

**CHERUBINI France S.a.r.l.**

ZI Du Mas Barbet  
165 Impasse Ampère  
30600 Vauvert - France  
Tél. +33 (0) 466 77 88 58 | Fax +33 (0) 466 77 92 32  
info@cherubini.fr | www.cherubini.fr

**CHERUBINI Deutschland GmbH**

Siemensstrasse, 40 - 53121 Bonn - Deutschland  
Tel. +49 (0) 228 962 976 34 / 35 | Fax +49 (0) 228 962 976 36  
info@cherubini-group.de | www.cherubini-group.de

