

CHERUBINI

tocco italiano dal 1947



CHERUBINI REMOTE CONTROL

A510020 TDS GOLD

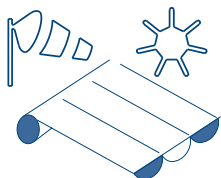
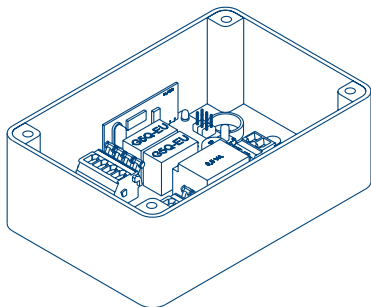

CENTRALINA PER TENDE DA SOLE

I

ELECTRONIC AWNING CONTROL UNIT

GB

FUNKEMPFÄNGER ZU MARKISEN

D

RÉCEPTEUR POUR STORES

F

CENTRALITA PARA TOLDOS

E



ISTRUZIONI - INSTRUCTIONS - EINSTELLANLEITUNGEN
INSTRUCTIONS - INSTRUCCIONES

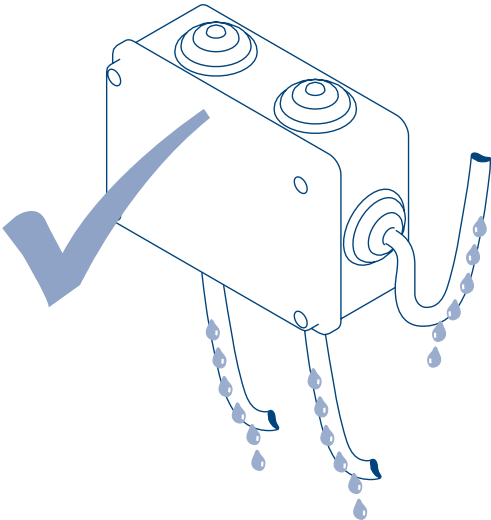
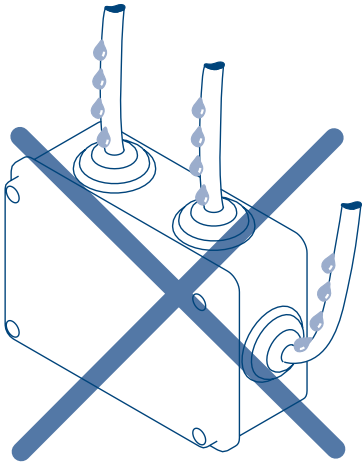

Table of contents:

Safety instructions	p. 22
Electrical connections	p. 22
Compatible remote controls	p. 25
Key to symbols	p. 26
Command sequences example	p. 27
Function open/close programming remote control	p. 28-29
Setting the first remote control	p. 30
Automatic disabling of the first remote control setting function	p. 30
Setting the rotation direction of the motor	p. 30
Setting of additional remote controls	p. 31
Remote control memory clearing	p. 31
Full memory clearing	p. 31
Time-out setting	p. 32
Compatible devices:	
Mistral	p. 33
Rugiada	p. 34
Anemometers	p. 34
Enable/disable the sun sensor (WindTec Lux)	p. 35
Test mode (WindTec/WindTec Lux)	p. 35
Wind sensor WindTec SC	p. 36
Switch	p. 37
Special functions: short-term setting of a remote control	p. 38
Technical features	p. 93
EU Declaration of conformity	p. 94

SAFETY INSTRUCTIONS

- Only professional technicians must perform installation, complying with all safety instructions, especially those regarding electrical connections.
- To avoid short circuits, arrange an automatic bipolar switch with opening distance of the contacts of at least 3 mm before the circuit.

ENGLISH

ELECTRICAL CONNECTIONS

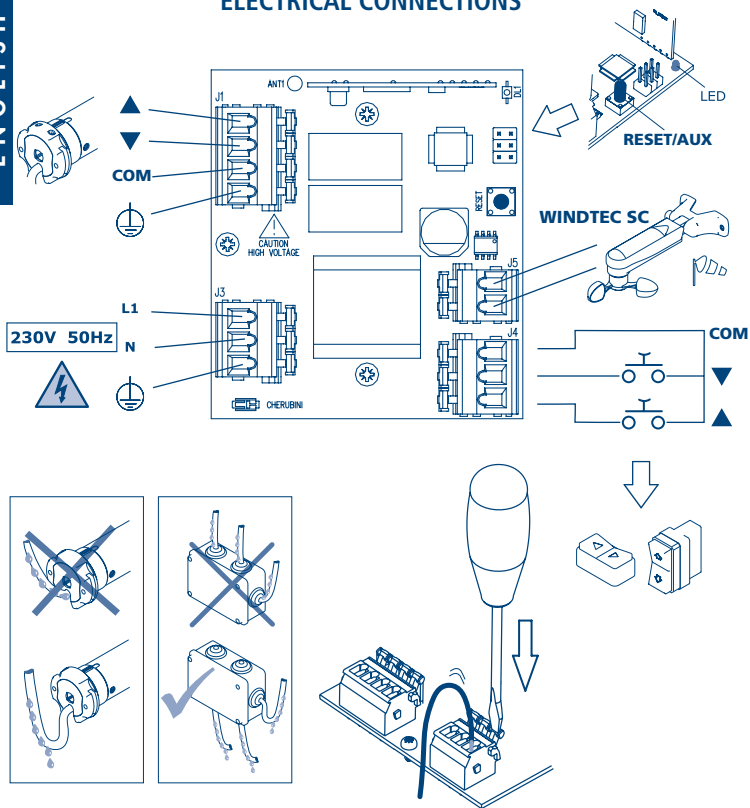

WINDTEC - Ref. A520007
WINDTEC LUX - Ref. A520008

MISTRAL
Ref. A520012

RUGIADA
Ref. A520016

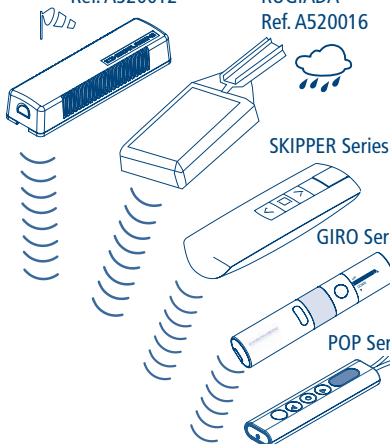
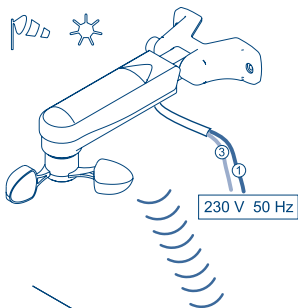

ENGLISH

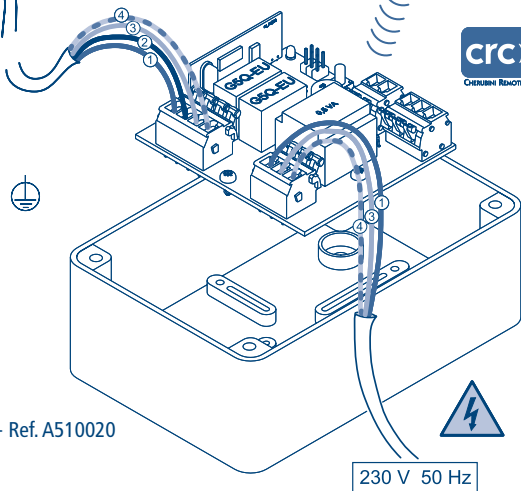
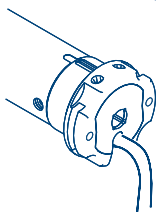

- ① BROWN
- ② BLACK
- ③ BLUE
- ④ YELLOW-GREEN 

TDS GOLD - Ref. A510020

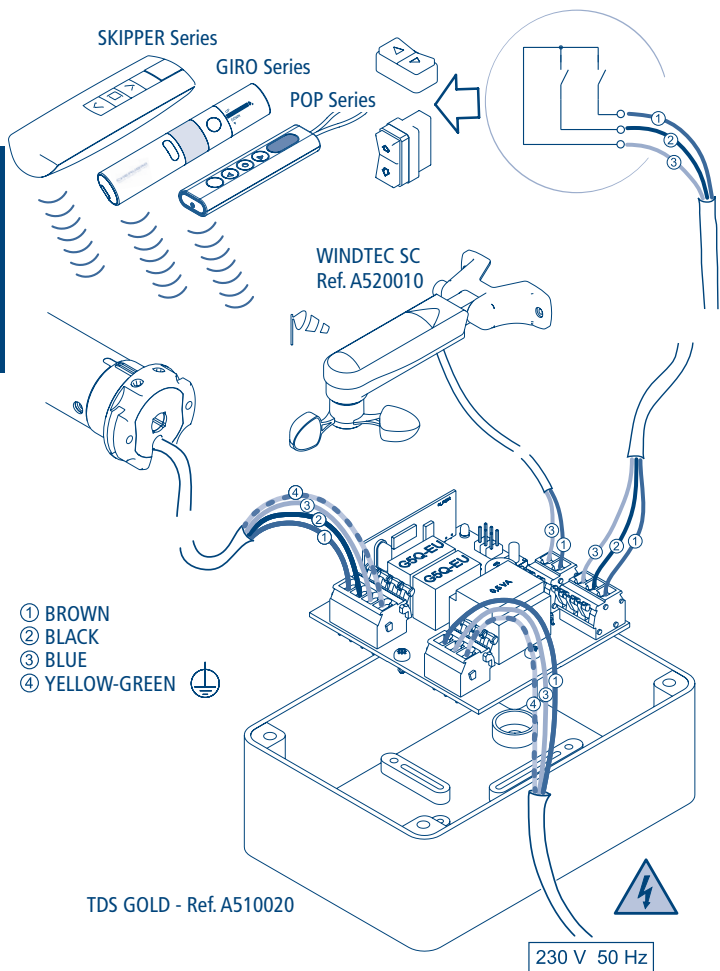

COMPATIBLE REMOTE CONTROLS

GIRO

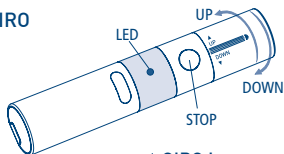

GIRO Wall

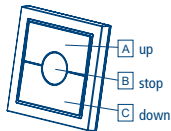

GIRO Plus

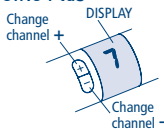

GIRO Lux

Activating the Sun sensor

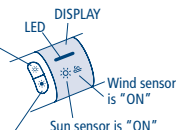

Deactivating the Sun sensor

GIRO P-Lux

Change channel



Activating/ Deactivating the Sun sensor

POP

POP Lux

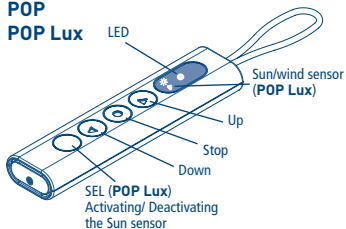

POP Plus

POP P-Lux

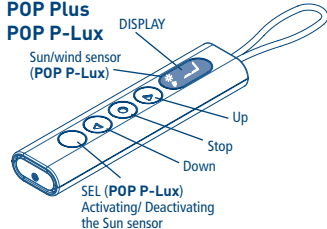

SKIPPER
SKIPPER **Lux**
SKIPPER **Plus**
SKIPPER **P-Lux**

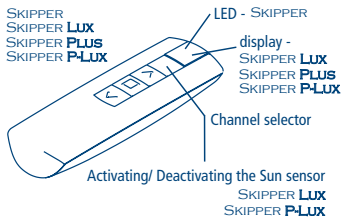

SKIPPER **LCD**
SKIPPER **SENSO**

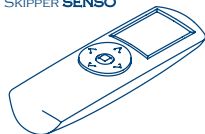

Check the specific instruction book

KEY TO SYMBOLS

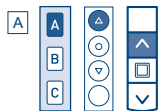
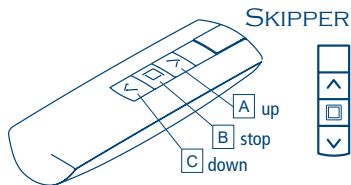
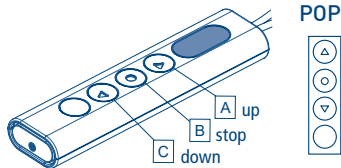
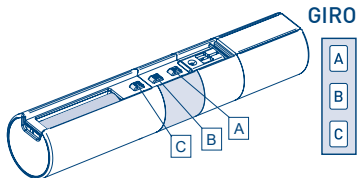
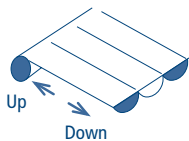

Press button A

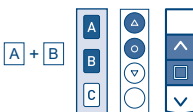

Press buttons A and B
at the same time



press the
DOWN button
on the switch



press the UP
button on the
switch

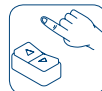

release the
button pressed
on the switch



short motor rotation
in one direction



long motor rotation
in other direction



double short
rotation

COMMAND SEQUENCES EXAMPLE

Most of the command sequences have three distinct steps, at the end of which the motor indicates if the step has been concluded positively or not, by turning in different ways. This section is provided to demonstrate the motor indications. The buttons must be pressed as shown in the sequence, without taking more than 4 seconds between one step and the next. If more than 4 seconds are taken, the command is not accepted and the sequence must be repeated.

Command sequence example:

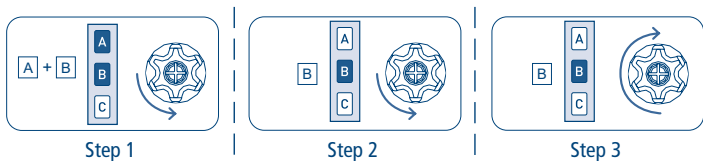

As we can see from the example, when the sequence ends positively, the motor returns to its starting position in one long rotation. In fact, two short rotations in the same direction correspond to one long rotation in the opposite direction. The motor returns to the starting position even when the sequence is not completed; in this case by performing one or two short rotations.

Example of a wrong sequence:

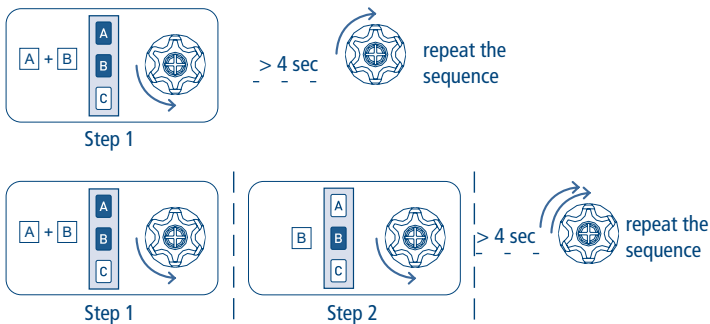

FUNCTION OPEN/CLOSE PROGRAMMING

REMOTE CONTROL SKIPPER PLUS - SKIPPER LUX - SKIPPER P-LUX

REMOTE CONTROL POP PLUS - POP LUX - POP P-LUX

To prevent accidental changes to the programming of the motor during the daily use of the remote control, the possibility of programming is disabled automatically 8 hours after sending the last sequence (A+B or B+C).

CHECKING THE STATUS OF THE FUNCTION

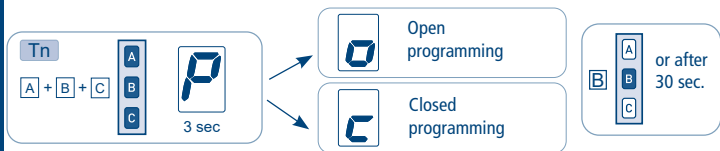

To change the status of the function, see the sequences "ENABLE/DISABLE PROGRAMMING".

ENABLE PROGRAMMING

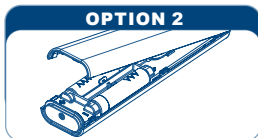
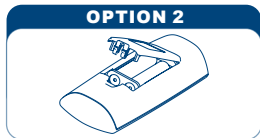

Remove and replace a battery

Proceed with programming as the instructions booklet.

DISABLE PROGRAMMING



FUNCTION OPEN/CLOSE PROGRAMMING

REMOTE CONTROL SKIPPER - SERIES GIRO - REMOTE CONTROL POP

To prevent accidental changes to the programming of the motor during the daily use of the remote control, the possibility of programming is disabled automatically 8 hours after sending the last sequence (A+B or B+C).

CHECKING THE STATUS OF THE FUNCTION

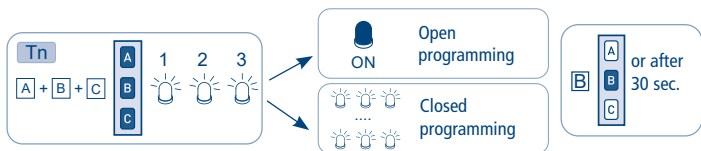

To change the status of the function, see the sequences "ENABLE/DISABLE PROGRAMMING".

ENABLE PROGRAMMING

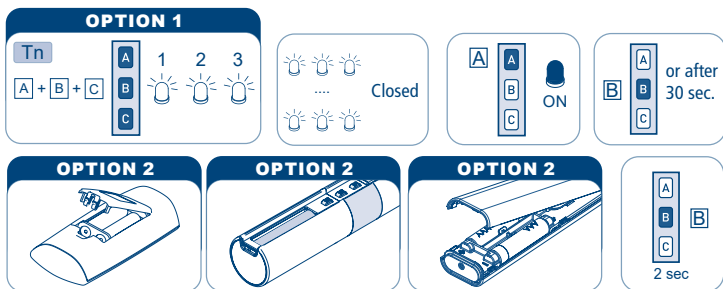

Remove one battery and wait minimum 5 seconds or press any button.

Proceed with programming as the instructions booklet.

DISABLE PROGRAMMING



SETTING THE FIRST REMOTE CONTROL

This operation can only be performed when the control unit is new, or after a total delete of the memory.

During this step, power up only one control unit at time!

T1: First remote control to be set

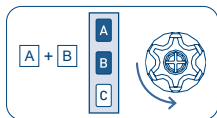

T1

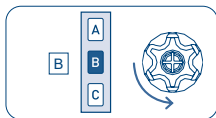

T1

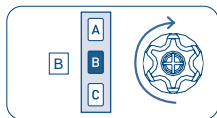

T1 (2 sec)

AUTOMATIC DISABLING OF THE FIRST REMOTE CONTROL SETTING FUNCTION

Every time you connect the power supply to the control unit, you have 3 hours to store the first remote control. After this time, the ability to store the remote control is disabled. To reset the timer of the function you have to disconnect and reconnect the power supply to the control unit.

SETTING THE ROTATION DIRECTION OF THE MOTOR

This operation is mandatory if the rotation direction of the motor does not match to the UP and DOWN functions of the remote control as an exemple if giving UP command the awning descend.

The proper motor direction must be set, if the motor is linked to a Wind sensor. In case of a wind alarm, the motor will always perform the command associated to the UP button.

Setting the rotation direction using the button **RESET/AUX**:

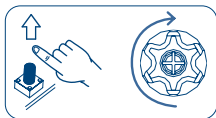

max 2 sec

Interchanging the **BROWN** and **BLACK** motor wire on the terminals of the control unit, will also reverse the rotation direction.

The control unit will keep this setting even after complete memory clearing!!

SETTING OF ADDITIONAL REMOTE CONTROLS

Up to 15 remote controls can be set, including the light/wind sensor and the rain sensor.

Tn: Already programmed remote control

Tx: Additional remote control

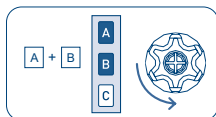

Tn

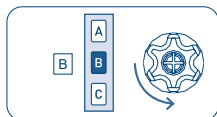

Tn

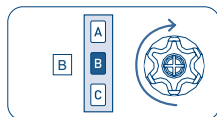

Tx (2 sec)

REMOTE CONTROL MEMORY CLEARING

It is possible to delete each memorized remote control individually. As the last one is deleted the control unit initial condition is restored. The same applies to the single channels of a multichannel remote control: just select the channel to cancel.

Tn: Remote control to be cleared

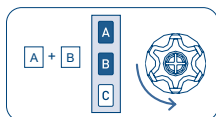

Tn

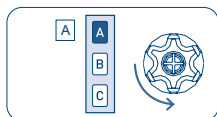

Tn

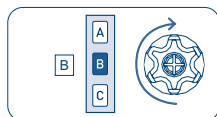

Tn (2 sec)

FULL MEMORY CLEARING

The full memory clearing can be performed in two ways:

1) WITH THE REMOTE CONTROL

Tn: Already programmed remote control

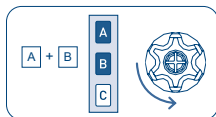

Tn

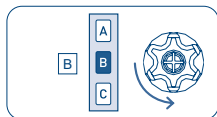

Tn

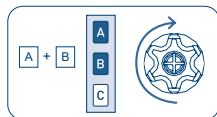

Tn (4 sec)

2) WITH THE BUTTON RESET/AUX:



(8 sec)

TIME-OUT SETTING

Time-out is the time during which the control unit is active, that's to say an opening or closing order is given. This time must always be longer than the opening-closing time of the device being controlled. The time-out ends after pressing the STOP button or also after the set value.

From factory setting: **90 seconds**

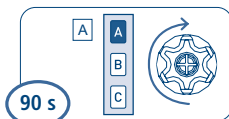
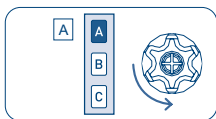
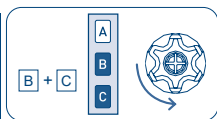

The control unit will keep this setting even after complete memory clearing!

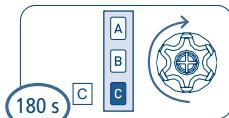
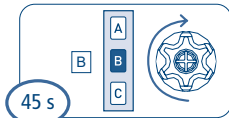

2 sec

COMPATIBLE DEVICES

MISTRAL SENSOR

It detects movements caused by the wind on the awning arms.

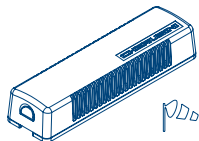

MISTRAL- Ref. A520012

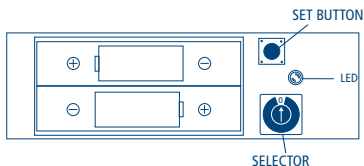

SETTING THE SENSOR

To associate the sensor to the control unit, a remote control must be already memorized. Set the selector to the 0 position and then perform this sequence:

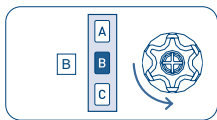
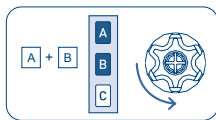

2 sec

DELETING THE SENSOR

To delete the sensor from the control unit, an already programmed remote control must be used. Set the selector to the 0 position; if active wait for the sensor to go off and then perform this sequence:

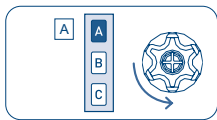
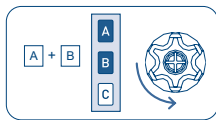

2 sec

For the complete description of the functions of this device see the instruction booklet that came in the box.

RUGIADA (TX RAIN-SENSOR)

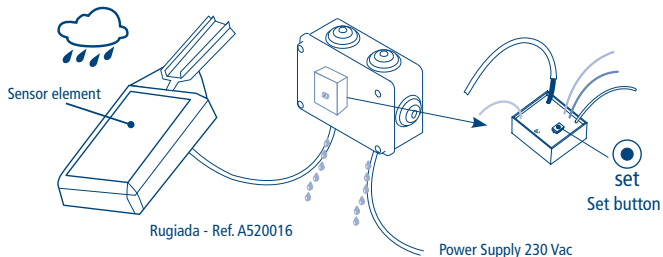

ANEMOMETERS



SETTING

To associate the sensor to the control unit, a remote control must be already memorised. The setting sequence is the following:

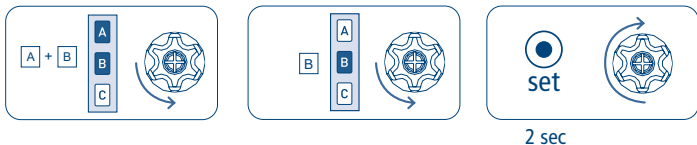

DELETING

To delete the sensor from the control unit, an already programmed remote control must be used. The deleting sequence is the following:

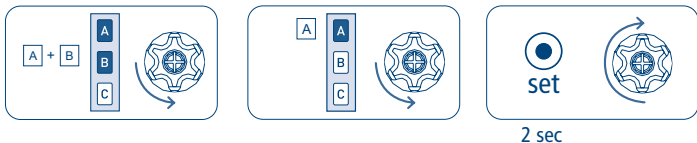

For the complete description of the functions of these devices see the instruction booklet that came in the box.

ENABLE / DISABLE THE SUN SENSOR

(WindTec Lux)

To enable (automatically) or disable (manually) the sun sensor refer to the instruction manual provided with the sensor or the remote control you want to use.

TEST MODE (WINDTEC/WINDTEC LUX)

This function is useful to check proper radio communications and to perform the wind and sun function test.

To activate the TEST function, hold the SET button down for around 2 seconds, until the awning opens for 10 seconds and closes briefly to confirm that the test has been activated. The Test function lasts for 3 minutes, during which the wind and sunlight threshold settings can be checked, without waiting for activation times. After 3 minutes, the WindTec sensor returns to normal operational mode. During the wind-alarm the red led inside the control unit is on.

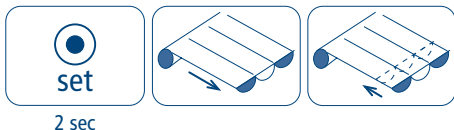

WIND FUNCTION TEST (WINDTEC, WINDTEC LUX)

To avoid errors during the wind function test, it is suggested that the sunlight function be deactivated. By spinning the anemometer fins, when the speed detected by the sensor exceeds the threshold set, the motor commands the closing of the awnings.

SUN FUNCTION TEST (WINDTEC LUX)

Make sure that the sunlight function is on. When the sensor detects a change in the sunlight intensity, it opens the awning if the sunlight intensity goes above the threshold set, or it closes the awning if the light intensity goes below the threshold set. It is possible to repeat this test several times, so as to find the desired adjustment levels precisely.

WIND SENSOR WINDTEC SC

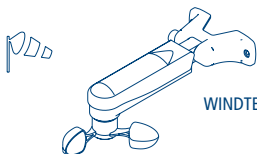

WINDTEC SC - Ref. A520010

This kind of Wind-sensor must be wired to the control unit on the indicated terminals, without respecting the polarity. Exceeding the set level the control unit will automatically perform the command associated to UP ward function of the remote control. So check that the rotation direction will correctly match this function. If not it's absolutely necessary to set the rotation direction. The "Wind-alarm" time is 8 minutes during which the control unit will not accept any command. During the wind-alarm the red led inside the control unit blinks.

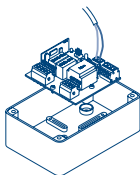
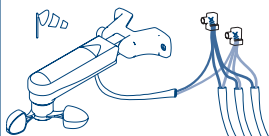

WARNING:
do not connect more than 5 control units to one anemometer WindTec SC.

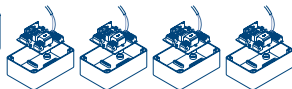

WIND-SPEED SETTING (WINDTEC SC)

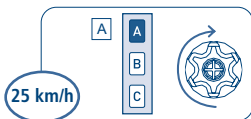
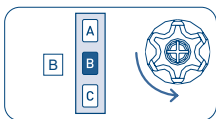
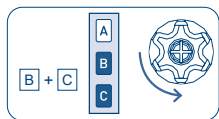

In factory set on: **25 km/h**

The control unit will keep the wind-speed setting even after complete memory clearing!!

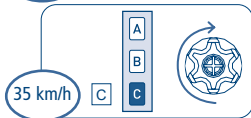
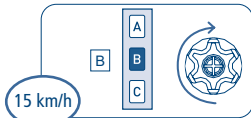

2 sec

TEST FOR WIND-SENSOR (WINDTEC SC)

This function is useful to check the correct connection to the control unit and the rotation direction in case of wind-alarm.

Activate the TEST function, with the sequence B+C, C. The awning opens for 10 seconds and closes briefly to confirm that the test mode is activated. Move the anemometer blades by hand, the motor performs short moves in closing direction. If the direction is not right it's necessary to invert the rotation direction. To quit the test mode press any button from the remote control. During the wind-alarm the red led inside the control unit is on.

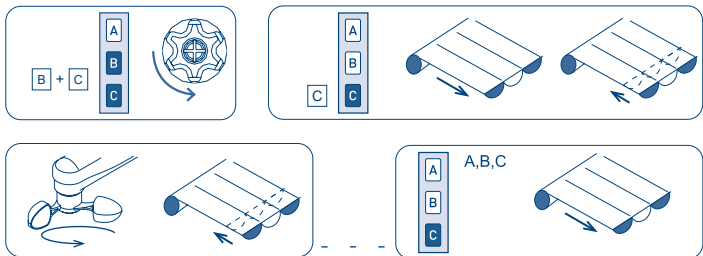

SWITCH

It is possible to run the motor through a switch connected to the control unit with three wires (up, down and common).

The switch must be equipped with mechanical or electrical interlock, to prevent two commands being sent simultaneously. Furthermore, the switch must be an unstable pushbutton: releasing it, the switch opens.

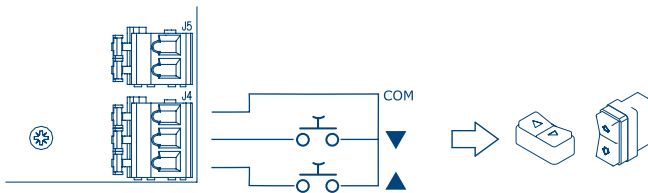

OPERATION

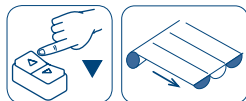

Pressing one of the two buttons and releasing, the motor drives to the desired direction until it reaches the limits.

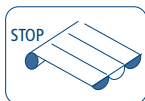
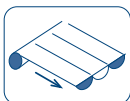

To stop the motor before reaching the limits press again the same button.

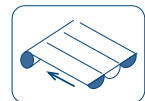
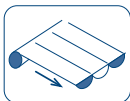

If during the movement the other button is pressed the motor changes the direction.

SPECIAL FUNCTIONS

SHORT-TERM SETTING OF A REMOTE CONTROL

This function makes it possible to store a remote control temporarily, for example, with the purpose of setting the limit switches during assembly in the factory. A later final saving of the remote control will be possible using the appropriate command sequence (see: "SETTING THE FIRST REMOTE CONTROL"). The operations described below can be carried out only when the control unit has just come out of the factory or after a full memory clearing (see: "FULL MEMORY CLEARING"). The control unit makes the following operations possible only within the time limits described in order to make sure that the short-term setting is used only in the installation or factory setting phase and not during daily use. Power up the control unit, make sure that no other control units having an empty memory are powered up in the same operating range.

Within 30 seconds after start, press the B and C buttons simultaneously until the motor gives a confirmation signal.

The remote control will remain stored for 5 minutes, while the control unit is powered up. After 5 minutes or when the control unit has its power cut off, the remote control will be cancelled.

T1: First remote control to be stored

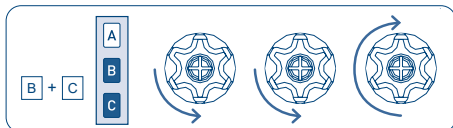

T1

CARATTERISTICHE TECNICHE

- Alimentazione	230 V / 50 Hz
- Potenza assorbita	2 W
- Frequenza radio	433,92 MHz
- Codifica	Rolling code
- Modulazione	AM/ASK
- Num. max trasmettitori	15
- Potenza max motore	500 W
- Temperatura di funzionamento	-10°C +55°C
- Dimensioni	120 x 80 x 50 mm
- Peso	300 g
- Grado di protezione	IP55

TECHNICAL FEATURES

- Power supply	230 V / 50 Hz
- Power consumption	2 W
- Radio frequency	433,92 MHz
- Decoder system	Rolling code
- Modulation	AM/ASK
- Max. number storable transmitters	15
- Max motor power	500 W
- Operating temperature	-10°C +55°C
- Dimensions	120 x 80 x 50 mm
- Weight	300 g
- Protection degree	IP55

TECHNISCHE EIGENSCHAFTEN

- Spannung	230 V / 50 Hz
- Leistungsaufnahme	2 W
- Funkfrequenz	433,92 MHz
- Decoder System	Rolling code
- Modulation	AM/ASK
- Max. einstellbare Handsender	15
- Max. Motor Leistung	500 W
- Betriebstemperatur	-10°C +55°C
- Abmessungen	120 x 80 x 50 mm
- Gewicht	300 g
- Schutzgrad	IP55

CARACTÉRISTIQUES TECHNIQUES

- Alimentation	230 V / 50 Hz
- Puissance absorbée	2 W
- Fréquence radio	433,92 MHz
- Codification	Rolling code
- Modulation	AM/ASK
- Nombre maxi. d'émetteurs	15
- Puissance maxi. du moteur	500 W
- Température de fonctionnement	-10°C +55°C
- Dimensions	120 x 80 x 50 mm
- Poids	300 g
- Indice de protection	IP55

CARACTERÍSTICAS TÉCNICAS

- Alimentación	230 V / 50 Hz
- Potencia absorbida	2 W
- Frecuencia radio	433,92 MHz
- Codificación	Rolling code
- Modulación	AM/ASK
- Núm. máx. emisores	15
- Potencia máx motor	500 W
- Temperatura de funcionamiento	-10°C +55°C
- Dimensiones	120 x 80 x 50 mm
- Peso	300 g
- Grado de protección	IP55



I DICHIARAZIONE DI CONFORMITÀ UE

CE CHERUBINI S.p.A. dichiara che il prodotto è conforme alle pertinenti normative di armonizzazione dell'Unione:

Direttiva 2014/53/UE, Direttiva 2011/65/UE.

Il testo completo della dichiarazione di conformità UE è disponibile facendone richiesta sul sito: www.cherubini.it.

GB EU DECLARATION OF CONFORMITY

CE CHERUBINI S.p.A. declares that the product is in conformity with the relevant Union harmonisation legislation:

Directive 2014/53/EU, Directive 2011/65/EU.

The full text of the EU declaration of conformity is available upon request at the following website: www.cherubini.it.

D EU-KONFORMITÄTSEKTLÄRUNG

CE CHERUBINI S.p.A. erklärt der produkt erfüllt die einschlägigen Harmonisierungsrechtsvorschriften der Union:

Richtlinie 2014/53/EU, Richtlinie 2011/65/EU.

Der vollständige Text der EU-Konformitätserklärung kann unter unserer Web-Seite www.cherubini.it, gefragt werden.

F DÉCLARATION UE DE CONFORMITÉ

CE CHERUBINI S.p.A. déclare que le produit est conforme à la législation d'harmonisation de l'Union applicable:

Directive 2014/53/UE, Directive 2011/65/UE.

Le texte complet de la déclaration UE de conformité est disponible en faisant requête sur le site internet: www.cherubini.it.

E DECLARACIÓN UE DE CONFORMIDAD

CE CHERUBINI S.p.A. declara que el producto es conforme con la legislación de armonización pertinente de la Unión:

Diretiva 2014/53/UE, Directiva 2011/65/UE.

El texto completo de la declaración UE de conformidad puede ser solicitado en: www.cherubini.it.

CHERUBINI S.p.A.

Via Adige 55
25081 Bedizzole (BS) - Italy
Tel. +39 030 6872.039 | Fax +39 030 6872.040
info@cherubini.it | www.cherubini.it

CHERUBINI Iberia S.L.

Avda. Unión Europea 11-H
Apdo. 283 - P. I. El Castillo
03630 Sax Alicante - Spain
Tel. +34 (0) 966 967 504 | Fax +34 (0) 966 967 505
info@cherubini.es | www.cherubini.es

CHERUBINI France S.a.r.l.

ZI Du Mas Barbet
165 Impasse Ampère
30600 Vauvert - France
Tél. +33 (0) 466 77 88 58 | Fax +33 (0) 466 77 92 32
info@cherubini.fr | www.cherubini.fr

CHERUBINI Deutschland GmbH

Siemensstrasse, 40 - 53121 Bonn - Deutschland
Tel. +49 (0) 228 962 976 34 / 35 | Fax +49 (0) 228 962 976 36
info@cherubini-group.de | www.cherubini-group.de

